



NEWS 2023

Große Vielfalt, schneller Überblick

uma Schreibgeräte setzen sich aus vielen Komponenten zusammen, mit einer Vielfalt an Farboptionen und unterschiedlichen Druckpositionen. Zur schnellen Übersicht über die verfügbaren Gestaltungsmöglichkeiten finden Sie auf jeder Produktseite eine Produkt-Info-Skizze mit dem jeweiligen Schreibgerät, der gesamten Auswahl an Standard-Farben des Modells und den Angaben der zur Verfügung stehenden Druckpositionen mit entsprechenden Maßen (Länge x Höhe in mm).

Für die Beschreibung der Druckposition und der Druckverfahren gibt es spezielle Info-Schlüssel, vgl. unten. Bitte achten Sie auf die Nummer (①–⑦) der jeweilig verfügbaren Druckposition bzw. auf den Buchstaben (Druckschlüssel S, T, TT, L, EL, RL, RD, HD, V, D, MT, MS, P, GS, GT) des entsprechend geeigneten Druckverfahrens.

uma – große Vielfalt, schneller Überblick.

Druckpositionen

- ① auf dem Clip
- ② in Clipverlängerung
- ③ gegenüber dem Clip
- ④ seitlich vom Clip
- ⑤ auf der Kappe
- ⑥ Stopfen
- ⑦ seitliche Clipbefestigung

Druckverfahren (Druckschlüssel)

- S = Siebdruck
- T = Tampondruck
- TT = Tampondruck auf Sonderformaten
- L = Lasergravur
- EL = Einzelnamensgravur
- RD = Reliefdruck
- RL = Rundumlasergravur
- HD = Digitaldruck
- V = Visual-Folientransferdruck
- D = Doming

- Tampon- oder Siebdruck auf Metall, Holz oder lackierten bzw. gummierten Oberflächen:**
- MS = Siebdruck
- MT = Tampondruck
- P = Sonderdruck
- GS = Siebdruck auf gummierten Oberflächen
- GT = Tampondruck auf gummierten Oberflächen

○ = Rundumdruck möglich ◀▶ = Mix 'n Match Modell ◊ = Uni-Modell □ = Etikettendruck möglich

Hinweise zu Farb-Codes

Die komplette Farbauswahl der Produkte wurde in Form von Einklinkern abgebildet. Die dazugehörigen Farbcodes setzen sich so zusammen, dass die letzten vier Ziffern der jeweiligen PMS-Farbe entsprechen. Basierend auf

den Nummern des Pantone-Farbfächers. Da es sich hierbei um unverbindliche Angaben handelt, bitte vor einer Bestellung die Originalmuster zur Freigabe anfordern.

Wichtig: Zu jeder Bestellung die Farbnummern angeben!

The Whole Range at a Glance

uma writing instruments combine numerous components with a wide range of colour options and various print positions. With all these design choices, it's a good thing every product page has an informative product sketch of each writing instrument, the full range of standard colours for the model and information about available imprint positions with dimensions (length x height in mm).

There are special information codes describing imprint positions and printing methods – see below for more. Please note the number (①–⑦) of the available imprint position and the letter (printing code S, T, TT, L, EL, RL, RD, HD, V, D, MT, MS, P, GS, GT) of your chosen printing method.

At uma, you can see the whole range at a glance.

Print Positions

- ① On the clip
- ② In front of the clip
- ③ On the opposite side of the clip
- ④ Beside the clip
- ⑤ On the cap
- ⑥ Plug
- ⑦ Lateral clip fastening

Printing Methods (Printing Code)

- S = Silk screen
- T = Pad printing
- TT = Pad printing on special formats
- L = Laser engraving
- EL = Individual name engraving
- RD = Relief printing
- RL = 360° Laser engraving
- HD = Digital printing
- V = Foil transfer imprint
- D = Doming

- Pad or silk screen printing on metallic, wooden or laquered rather rubberized surfaces:**
- MS = Silk screen
- MT = Pad printing
- P = Special print
- GS = Silk screen on rubberized surfaces
- GT = Pad printing on rubberized surfaces

○ = All-around imprint ◀▶ = Mix 'n Match Model ◊ = One-coloured model □ = Label printing possible

Notes On The Colour Codes

The complete colour selection of the products has been depicted in the form of inserts. The respective colour codes are comprised in such a way that the last four numbers correspond to the respective PMS colour. Based on the numbers of the Pantone colour palette.

As this is non-binding information, please request the original samples for approval before placing an order.

Important: Please indicate the colour numbers with each order!

Natur/Nature



Innovation, Klimaschutz, Nachhaltigkeit / Innovation, Climate protection, Sustainability 10 – 13

	RECYCLED PET PEN STEP	4 – 5
	RECYCLED PET PEN PRO	6 – 9
	RECYCLED PET PEN PRO R + FL	14 – 15
	RECYCLED PET PEN PRO LIQEO	16 – 17
	RECYCLED PET PEN PRO SI	18 – 19
	RECYCLED PE PEN PRO F ocean	20 – 21
	RECYCLED PET PEN PRO antibacterial	22 – 25
	RECYCLED PET PEN PRO F TOUCH	26 – 27
	RECYCLED PET PEN ALUMA	28 – 29







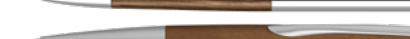

rABS und rPCP – recycelter Kunststoff / rABS and rPCP – recycled plastic 30 – 31

	YES RECY	32
	HAPPY RECY	33
	VANE RECY	34 – 35
	ON TOP RECY	36
	PIXEL RECY	37

Holz – Wood

	TREE	38 – 39
	LEAF	39
	TITAN WOOD	40 – 41
	ELEGANCE WOOD	42 – 43

Kunststoff – Plastic

	NFC	44
	TRINITY	45 – 47
	QR-CODE PRINT	46
	CORAL	48 – 51
	HAPPY	52 – 53
	SKY	54 – 55
	STREAM	56 – 57
	CHECK	58 – 59

Metall – Metal

	GROOVE	60 – 61
	PYRA	62 – 63
	MESH	64 – 65
	TITAN	66 – 67
	ELEGANCE	68 – 69



Etui Empfehlung / Case suggestion
 ETUI 0-0940 CI rPET
 Informationen unter www.uma-pen.com
 Information at www.uma-pen.com

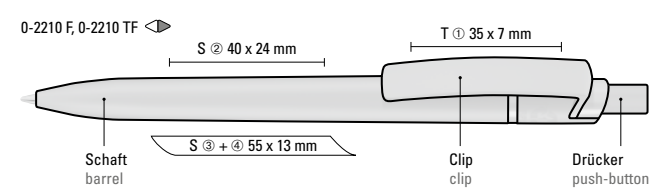

Farb-Code/Minen
 Colour code/Refills

RECYCLED PET PEN STEP F
 0-2210 F

RECYCLED PET PEN STEP frozen
 0-2210 TF

0-2210 F (● 8-0854)		0-2210 TF (● 8-0854)	
	57-0298		57-0286
	57-0662		57-0185
	57-0200		57-0355
	57-0361		57-0440
	57-0340		57-0291
	57-0002		57-0107
	57-7527		57-0260
	57-0001		57-0226
	57-0012		57-0151
	57-0021		57-3295
	● 8-0854		● 8-0854

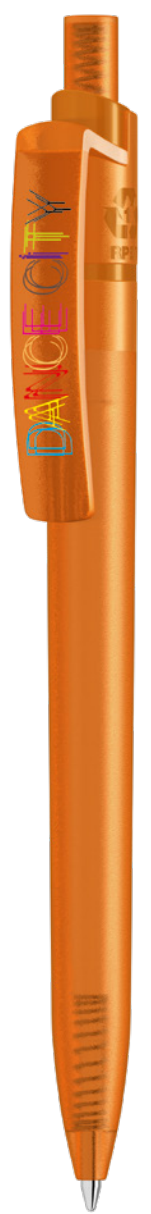

Das aus recycelten PET-Flaschen in Europa hergestellte rPET-Material eignet sich für einen langlebigen und nachhaltigen Werbeinsatz. Dank der europäischen und klimaneutralen Produktion leistet der uma RECYCLED PET PEN STEP einen zusätzlichen nachhaltigen Beitrag zur Schonung der Umwelt. Aufgrund der Besonderheiten des Materials (recyceltes PET-Material) sind produktionstechnische Farbschwankungen gegeben.

The rPET material, which is produced in Europe from recycled PET bottles, is suitable for a durable and sustainable advertisement. Thanks to the European and climate-neutral production, the uma RECYCLED PET PEN STEP makes an additional sustainable contribution to the protection of the environment.

Due to the special nature of the material (recycled PET material) production-related variations are possible.



Mix n' Match: Ab 2.000 Stück kann das Modell farblich kombiniert werden.

0-2210 F: Druckkugelschreiber aus recyceltem PET-Material mit matt gedecktem Gehäuse, Clip und Drücker.
 0-2210 TF: Druckkugelschreiber aus recyceltem PET-Material mit transparent gefrostem Gehäuse, Clip und Drücker.

Mindestbestellmenge
 Werbeschlüssel

1.000 Stück
 Schaft S, Clip T

Mix n' Match: From 2,000 pieces, you can choose any colour combination.

0-2210 F: Retractable ballpoint pen made from recycled PET material with opaque matt housing, clip and push-button.
 0-2210 TF: Retractable ballpoint pen made from recycled PET material with transparent frosted housing, clip and push-button.

Minimum quantity
 Advertising code

1,000 pieces
 barrel S, clip T

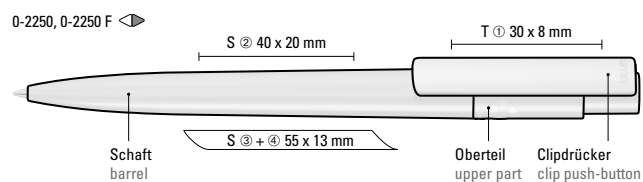

Farb-Code/Minen
Colour code/Refills

RECYCLED PET PEN PRO
0-2250

RECYCLED PET PEN PRO F
0-2250 F

0-2250 (● 8-0854)
0-2250 F (● 8-0854)

- 57-0298
- 57-0662
- 57-0200
- 57-7492
- 57-0361
- 57-0340
- 57-0002
- 57-7527
- 57-0001
- 57-0012
- 57-0270
- 57-2607
- 57-0233
- 57-0021
- 57-7710
- 57-7500
- Umic Economy Refill 5.0854
- 8-0854



UMIC PRIME



Das aus recycelten PET-Flaschen in Europa hergestellte rPET-Material eignet sich für einen langlebigen und nachhaltigen Werbeeinsatz. Dank der europäischen und klimaneutralen Produktion leistet der uma RECYCLED PET PEN PRO einen zusätzlichen nachhaltigen Beitrag zur Schonung der Umwelt. Aufgrund der Besonderheiten des Materials (recyceltes PET-Material) sind produktionstechnische Farbschwankungen gegeben.

The rPET material, which is produced in Europe from recycled PET bottles, is suitable for a durable and sustainable advertisement. Thanks to the European and climate-neutral production, the uma RECYCLED PET PEN PRO makes an additional sustainable contribution to the protection of the environment. Due to the special nature of the material (recycled PET material) production-related variations are possible.



Mix n' Match: Ab 2.000 Stück kann das Modell farblich kombiniert werden.

0-2250: Druckkugelschreiber aus recyceltem PET-Material mit gedeckt glänzendem Gehäuse und Clip.

0-2250 F: Druckkugelschreiber aus recyceltem PET-Material mit matt gedecktem Gehäuse und Clip.

Mindestbestellmenge
Werbeschlüssel

1.000 Stück
Schaft S, Clip T

Mix n' Match: From 2,000 pieces, you can choose any colour combination.

0-2250: Retractable ballpoint pen made from recycled PET material with opaque glossy housing and clip.

0-2250 F: Retractable ballpoint pen made from recycled PET material with opaque matt housing and clip.

Minimum quantity
Advertising code

1,000 pieces
barrel S, clip T

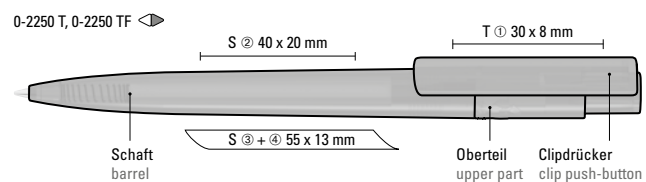

Farb-Code/Minen
Colour code/Refills

RECYCLED PET PEN PRO transparent
0-2250 T

RECYCLED PET PEN PRO frozen
0-2250 TF

0-2250 T (● 8-0854)
0-2250 TF (● 8-0854)

- 57-0286
- 57-0185
- 57-0355
- 57-0440
- 57-0291
- 57-0107
- 57-0260
- 57-0226
- 57-0151
- 57-3295
- UTMCI Economy Refill S-0054 ● 8-0854



Etui Empfehlung/Case suggestion
ETUI 0-0955 rPET
Informationen unter www.uma-pen.com
Information at www.uma-pen.com



UMA PRIME



Das aus recycelten PET-Flaschen in Europa hergestellte rPET-Material eignet sich für einen langlebigen und nachhaltigen Werbeeinsatz. Dank der europäischen und klimaneutralen Produktion leistet der uma RECYCLED PET PEN PRO einen zusätzlichen nachhaltigen Beitrag zur Schonung der Umwelt. Aufgrund der Besonderheiten des Materials (recyceltes PET-Material) sind produktionstechnische Farbschwankungen gegeben.

The rPET material, which is produced in Europe from recycled PET bottles, is suitable for a durable and sustainable advertisement. Thanks to the European and climate-neutral production, the uma RECYCLED PET PEN PRO makes an additional sustainable contribution to the protection of the environment. Due to the special nature of the material (recycled PET material) production-related variations are possible.



Mix n' Match: Ab 2.000 Stück kann das Modell farblich kombiniert werden.

0-2250 T: Druckkugelschreiber aus recyceltem PET-Material mit transparentem Gehäuse und Clip.

0-2250 TF: Druckkugelschreiber aus recyceltem PET-Material mit transparent gefrostedem Gehäuse und Clip.

Mindestbestellmenge
Werbeschlüssel

1.000 Stück
Schaft S, Clip T

Mix n' Match: From 2,000 pieces, you can choose any colour combination.

0-2250 T: Retractable ballpoint pen made from recycled PET material with transparent housing and clip.

0-2250 TF: Retractable ballpoint pen made from recycled PET material with transparent frosted housing and clip.

Minimum quantity
Advertising code

1,000 pieces
barrel S, clip T

Tradition basiert auf ständigen Innovationen

Bei dem Innovationswettbewerb TOP 100 hat uma es nach 2019 auch in 2022 wieder unter die Besten geschafft. In einem unabhängigen Auswahlverfahren konnten wir besonders mit innovativen Prozessen und innovativem Management nachhaltig punkten. Dass sich zukunftssträchtiges Agieren auch in innovativen Produkten niederschlägt, konnte mit der uma RECYCLED PET PEN-Serie eindrucksvoll bewiesen werden. Der Einsatz alternativer Materialien und die Investition in neue Produktionsverfahren macht uma zu einem der TOP 100 Innovativsten Unternehmen des Deutschen Mittelstandes.

Tradition is based on constant innovation

In the TOP 100 innovation competition, uma made it to the top again in 2022 after 2019. In an independent selection process, we scored particularly well with innovative processes and innovative management. With the uma RECYCLED PET PEN series, it was impressively demonstrated that future-oriented action is also reflected in innovative products. The use of alternative materials and the investment in new production processes make uma one of the TOP 100 most innovative companies in the German medium-sized sector.



uma Produktion ist klimaneutral

Der Klimawandel ist aktuell eine der größten Herausforderungen. Wir wollen Verantwortung übernehmen und leisten einen konkreten Beitrag zum Klimaschutz: In Zusammenarbeit mit ClimatePartner haben wir die Emissionen unserer uma „Naturals Serie“ berechnet und anschließend über regionale Klimaschutzprojekte ausgeglichen. Somit ist die erste uma klimaneutrale Schreibgeräte-Serie erhältlich.

Wir wären aber nicht uma, wenn wir uns nur auf ein Produkt konzentrieren würden. Aus diesem Grund haben wir die komplette Produktion in Fischerbach, im Herzen des Schwarzwaldes, auf klimaneutral gestellt. Wir freuen uns somit einen positiven Beitrag für die Umwelt leisten zu können.



uma production is climate-neutral

Climate change is currently one of the greatest challenges. We want to assume responsibility and make a concrete contribution to climate protection: In cooperation with ClimatePartner, we have calculated the emissions of our uma „Naturals series“ and then offset them through regional climate protection projects. Thus the first uma climate-neutral writing instruments serie is available.

But we wouldn't be uma if we only concentrated on one product. For this reason, we have set the complete production in Fischerbach, in the heart of the Black Forest, to climate-neutral. We are therefore pleased to be able to make a positive contribution to the environment.

uma nachweislich zertifiziert

Die Grundprinzipien unserer Produktionsbedingungen sind klar: Wir sehen es als unternehmerische Verantwortung, menschenwürdige und umweltverträgliche Arbeitsbedingungen sicherzustellen. Somit haben das Einhalten von Arbeitnehmerrechten, sowie der verantwortungsbewusste Umgang mit der Natur und ihren Ressourcen oberste Priorität. Deshalb werden alle uma Produktionsstätten regelmäßig von externen Einrichtungen auditiert und unsere Ansprüche bei persönlichen Besuchen und Briefings den Zulieferern vermittelt. Die Zusammenarbeit mit diesen Produktionsstätten basiert auf jahrelangen und familiären Verbindungen, die ein zusätzliches Sicherheits- und Qualitätsniveau in allen Belangen sicherstellt.

uma demonstrably certified

The basic principles of our production conditions are clear: We see it as our corporate responsibility to ensure humane and environmentally compatible working conditions. Respect for workers' rights and the responsible use of nature and its resources are therefore our top priorities. Therefore, all uma production sites are regularly audited by external institutions and our requirements are communicated to the suppliers during personal visits and briefings. The cooperation with these production sites is based on long-standing and family ties, which ensure an additional level of safety and quality in all matters.

Wie schreibt man „nachhaltig“?

Nachhaltigkeit – ein Thema, das uma schon seit vielen Jahren bewegt. Dies spiegelt sich nicht nur in unserer generationsübergreifenden und zukunftsorientierten Firmengeschichte wider, sondern auch in den innovativen uma Produktideen. Mit den uma RECYCLED PET PEN-Serien haben wir die erste tatsächlich nachhaltige Schreibgeräte-Serie entwickelt, die nicht nur in Haptik und Variationsmöglichkeit, sondern auch mit einer innovativen Recyclingidee überzeugt.

How do you write 'sustainable'?

Sustainability – a topic that has been on umas' agenda for many years. This is reflected not only in our generation-spanning and future-oriented company history, but also in the innovative uma product ideas. With the uma RECYCLED PET PEN series we have developed the first truly sustainable writing instrument series, which not only convinces in haptics and variation possibilities, but also with an innovative recycling idea.



Die uma RECYCLED PET PEN-Serie

Schreiben Sie mit der ersten in Europa gefertigten, komplett klimaneutralen, recycelten, nachhaltigen Schreibgeräte-Serie. Die uma RECYCLED PET PEN-Serie.

Mit Innovationen Werben

Die verschiedenen Schreibsysteme, neben dem klassischen Kugelschreiber, basieren alle auf einem eigens entwickelten und innovativen Tintenleitsystem. Die Patronen können in allen Schreibgeräten ausgewechselt und nachgerüstet werden. Langlebiges Schreiben und Werben ist somit garantiert. Die Kombination aus Schreibsystemen und recyceltem PET Material macht die uma RECYCLED PET PEN-Serie zu einer Weltneuheit. Die erste nachhaltige Schreibgeräte-Serie aus recyceltem PET Material, die komplett klimaneutral produziert wird, verleiht den werbenden Unternehmen in der Kommunikation nicht nur Nachhaltigkeit, sondern auch geschriebene Innovation. Die nachhaltige Schreibgeräte-Familie, uma RECYCLED PET PEN verspricht Werbekommunikation und Schreibvergnügen auf höchstem Niveau.

The uma RECYCLED PET PEN series

Write with the first European, climate neutral, recycled and sustainable produced writing instrument series. The uma RECYCLED PET PEN series.

Advertising with innovations

Along with the classic ballpoint pen, the various writing systems are all based on a specially developed and innovative ink flow system. The cartridges can be used and retrofitted. This guarantees long-lasting writing joy and appeal. The combination of writing systems and RECYCLED PET material makes the uma RECYCLED PET PEN series a world first. The first sustainable writing series made from recycled PET material, which is produced completely climate-neutral, gives companies looking to communicate attractively sustainable and written innovation. The sustainable uma RECYCLED PET PEN series guarantees promotional communication and an enjoyable writing experience of the highest quality.



Schreiben Sie: Die uma RECYCLED PET PEN-Serie mit folgenden Pro Argumenten
 Communicate: The uma RECYCLED PET PEN series with the following pro arguments

 <ul style="list-style-type: none"> Weltneuheit: Erste in Europa gefertigte, recycelte, komplett klimaneutrale Schreibgeräte-Serie aus rPET Material Ein Recyclingprozess wurde bereits durchlaufen. World first: First recycled, fully climate-neutral writing series produced from rPET material and made in Europe Already undergone a recycling process. 	 <ul style="list-style-type: none"> rPET Material zu 100 % aus recycelten PET Flaschen Eine 0,5 L PET Flasche ergibt genau ein Schreibgerätegehäuse Langlebiges, nachhaltiges Material – eignet sich zum Upcycling rPET material made 100 % from recycled PET bottles One 0,5 l PET bottle produces exactly one housing of a pen Long-lasting, sustainable material – suitable for upcycling
 <ul style="list-style-type: none"> Es werden ausschließlich PET Flaschen aus Europa verwendet (ausser Ocean Bound Plastic). Made in Europe Only PET bottles from Europe are used (excepted ocean-bound plastic). Made in Europe 	 <ul style="list-style-type: none"> Optimaler CO₂ - Fußabdruck Komplett klimaneutrale Produktion und Veredelung Low carbon footprint Fully climate-neutral production and processing
 <ul style="list-style-type: none"> Alle Schreibgeräte sind mit dem international bekannten „rPET RECY-Zeichen“ versehen Kann einem weiteren Recyclingprozess zugeführt werden All stationery features the internationally recognised “rPET RECY logo” Can be recycled further 	 <ul style="list-style-type: none"> Designs auch als antibakterielle und antivirale Variante erhältlich, zertifiziert nach ISO 22196 (antibakteriell) und nach ISO 21702 (antiviral) #gesundbleiPEN – Hygiene- und Nachhaltigkeitskonzept werden mit einem Schreibgerät erfüllt Designs also available as antibacterial an antiviral version, certified according to ISO 22196 (antibacterial) and to ISO 21702 (antiviral) #antibacterial – hygiene and sustainability concept are fulfilled with one writing instrument

-  Einzigartige Gehäusefarbpalette, zusätzliche Einfärbung nach PMS und Mix & Match-Service
- Unique housing colour range, additional colouring based on PMS and Mix & Match service

Vier Schreibsysteme – ein Design

- **Kugelschreiber** mit Dokumental® Schreibpaste ●●
- **Rollerball** ●●●●●●●●
- **Highlighter** mit Dokumental® Highlighterpaste, EN-71-3, ASTM D4326 ●●●●●●●●
- **Fineliner** mit Dokumental® Finelinerpaste, EN-71-3, ASTM D4326 ●●●●●●●●●●



Four writing systems – one design

- **Ballpoint pen** with Dokumental® writing ink ●●
- **Rollerball** ●●●●●●●●
- **Highlighter** with Dokumental® highlighter ink, EN-71-3, ASTM D4326 ●●●●●●●●
- **Fineliner** with Dokumental® finelinerpaste, EN-71-3, ASTM D4326 ●●●●●●●●●●

-  Geschlossener und kontrollierter Recycling- bzw. Produktionsprozess nach dem „Global Recycling Standard“ zertifiziert
- Zertifizierte und ausgezeichnete Idee
- Closed and controlled recycling and production process certified based on the “Global Recycling Standard”
- Certified and award-winning concept



Nachhaltigkeit kombiniert mit innovativer Schreibtechnologie – Das uma Tintenleitsystem

Dank der innovativen Weiterentwicklung der uma RECYCLED PET PEN PRO-Serie ergeben sich zusätzliche Varianten von Schreibsystemen und Werbeoptionen für den Kunden. Neben dem klassischen Kugelschreiber können weitere Schreibsysteme im identischen Design, aus recyceltem PET-Material mit den gleichen Nachhaltigkeitsvorteilen umgesetzt werden.

Sustainably combined with innovative writing technology – The uma ink flow system

Thanks to the innovative further development of the uma RECYCLED PET PEN PRO series, additional types of writing system and promotional options have been created for customers. Along with the classic ballpoint pen, other identical writing systems made from recycled PET material can be used with the same sustainability benefits.





Spüren Sie nachhaltigen Schreibgenuss auch mit dem uma Rollerball:

RECYCLED PET PEN PRO Rollerball

Ein Rollerball für den besonders feinen Strich. In der uma RECYCLED PET PEN PRO-Serie gleich in 8 Schreibfarben erhältlich. Unterschriften für Verträge oder für ein einfach schönes Schreibgefühl ergeben weitere Werbeeinsatzmöglichkeiten.

Bringen Sie zukunftsorientierte Entwicklungen auf den Punkt mit dem uma Fineliner:

RECYCLED PET PEN PRO Fineliner

Unterstreichen, hervorheben oder technisches Zeichnen, mit einem Fineliner kann der dünne Strich nicht nur präzise, sondern auch in Farbe umgesetzt werden. In der uma RECYCLED PET PEN PRO-Serie geht das mit 12 Standardfarben.

Experience the enjoyment of sustainable writing with the uma rollerball:

RECYCLED PET PEN PRO Rollerball

A rollerball for a particularly fine line. Available in 8 writing colours in the uma RECYCLED PET PEN PRO series. Signing contracts or for a simply exquisite writing experience result in additional promotional opportunities.

Get to the heart of future-oriented developments with the uma fineliner:

RECYCLED PET PEN PRO Fineliner

Emphasise, highlight or technical drawing – the thin streak of a fineliner can be precisely presented in colour format. 12 standard colours are available in the uma RECYCLED PET PEN PRO series.

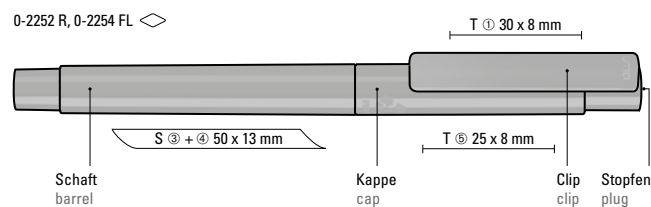

Farb-Code/Minen
Colour code/Refills

RECYCLED PET PEN PRO R
0-2252 R

RECYCLED PET PEN PRO FL
0-2254 FL

0-2252 R		0-2254 FL	
	57-0002		57-0002
	57-0001		57-0001
Tintenleitsystem/ ink flow system		Tintenleitsystem/ ink flow system	
	57-0298		57-0298
	57-0662		57-0662
	57-0200		57-0200
	57-0361		57-7492
	57-0002		57-0361
	57-2607		57-0002
	57-0233		57-7527
	57-0021		57-0012
			57-2607
			57-0233
			57-0021
			57-0478



0-2252 R
●●●●●●●●

0-2254 FL
●●●●●●●●



Das aus recycelten PET-Flaschen in Europa hergestellte rPET-Material eignet sich für einen langlebigen und nachhaltigen Werbeeinsatz. Dank der europäischen und klimaneutralen Produktion leistet der uma RECYCLED PET PEN PRO einen zusätzlichen nachhaltigen Beitrag zur Schonung der Umwelt. Aufgrund der Besonderheiten des Materials (recyceltes PET-Material) sind produktionstechnische Farbschwankungen gegeben.

The rPET material, which is produced in Europe from recycled PET bottles, is suitable for a durable and sustainable advertisement. Thanks to the European and climate-neutral production, the uma RECYCLED PET PEN PRO makes an additional sustainable contribution to the protection of the environment. Due to the special nature of the material (recycled PET material) production-related variations are possible.



0-2252 R: Rollerball mit Gehäuse aus recyceltem PET-Material in gedeckt glänzend weiß oder schwarz. Stopfen in den 8 möglichen Schreibfarben.

0-2254 FL: Fineliner mit Gehäuse aus recyceltem PET-Material in gedeckt glänzend weiß oder schwarz. Stopfen in den 12 möglichen Schreibfarben.

Mindestbestellmenge
Werbeschlüssel

1.000 Stück
Schaft S, Clip T, Kappe T

0-2252 R: Rollerball with opaque glossy housing in white or black made from recycled PET material. Plug in 8 possible writing colours.

0-2254 FL: Fineliner with opaque glossy housing in white or black made from recycled PET material. Plug in 12 possible writing colours.

Minimum quantity
Advertising code

1,000 pieces
barrel S, clip T, cap T



So schreiben Sie ab sofort Nachhaltigkeit auch mit dem uma Highlighter:

RECYCLED PET PEN PRO LIQEO

Textmarker sind aus dem täglichen Bürobedarf nicht mehr wegzudenken. Somit sind die Highlighter in 6 Schreibfarben sowohl für den internen Gebrauch, aber auch für die Abgabe als Werbe- und Kommunikationstool perfekt. Auch im Bereich Schule, Ausbildungsmessen oder Mitarbeiterrekrutierung können diese Modelle optimal eingesetzt werden.

Now you can write sustainably with the uma highlighter:

RECYCLED PET PEN PRO LIQEO

Text markers are an essential office item. Thus, the highlighters in 6 writing colours are suitable for office use and as an advertising and communication tool. These models can be optimally used in schools, at training fairs or employee recruitment.

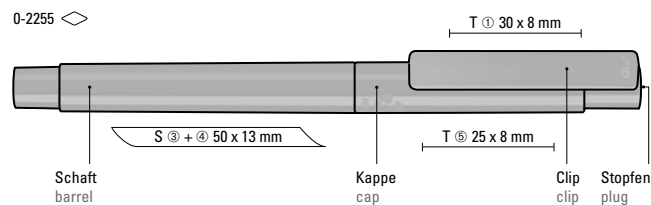

Farb-Code/Minen
Colour code/Refills

RECYCLED PET PEN PRO LIQEO
0-2255



Tintenleitsystem/
ink flow system

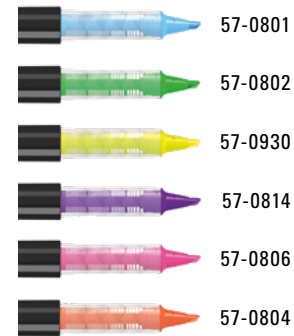

0-2255
●●●●●●

Das aus recycelten PET-Flaschen in Europa hergestellte rPET-Material eignet sich für einen langlebigen und nachhaltigen Werbeinsatz. Dank der europäischen und klimaneutralen Produktion leistet der uma RECYCLED PET PEN PRO LIQEO einen zusätzlichen nachhaltigen Beitrag zur Schonung der Umwelt. Der Highlighter ist ohne Pumpen oder Anstechen sofort einsatzfähig. Neues Flüssigtintenleitsystem – Bessere Schreibqualität – Höhere Leuchtkraft – Längere Schreibdauer – Umweltfreundlicher – Produziert nach EN-71, ASTM D-4236, Flüssigtank austausch- bzw. nachfüllbar. Aufgrund der Besonderheiten des Materials (recyceltes PET-Material) sind produktionstechnische Farbschwankungen gegeben.

The rPET material, which is produced in Europe from recycled PET bottles, is suitable for a durable and sustainable advertisement. Thanks to the European and climate-neutral production, the uma RECYCLED PET PEN PRO LIQEO makes an additional sustainable contribution to the protection of the environment. Writes longer and more intensive as conventional highlighter, is without pumping or tapping operational immediately, supported in this way the sustainability concept. New liquid ink delivery system – better writing quality – greater luminance – longer writing time – ecologically superior – produced in acc. with EN-71, ASTM D-4236, liquid tank replaceable or refillable. Due to the special nature of the material (recycled PET material) production-related variations are possible.

0-2255: Flüssig-Textmarker mit Gehäuse aus recyceltem PET-Material in gedeckt glänzend weiß oder schwarz. Stopfen in den 6 möglichen Schreibfarben.

Mindestbestellmenge
Werbeschlüssel

1.000 Stück
Schaft S, Clip T, Kappe T



0-2255: Liquid highlighter with opaque glossy housing in white or black made from recycled PET material. Plug in 6 possible writing colours.

Minimum quantity
Advertising code

1,000 pieces
barrel S, clip T, cap T

RECYCLED PET PEN PRO SI

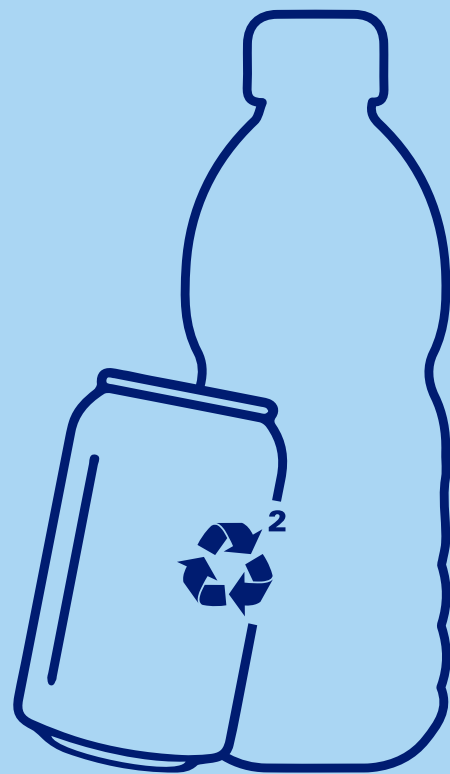

RECYCLED PET PEN PRO SI Recycled² – die nachhaltigste Kombination in einem Schreibgerät!

Recycelte PET-Getränke Flaschen treffen auf recycelte Aluminium Getränkedosen. Die uma rPET PRO Serie ist eine der nachhaltigsten Schreibgeräteentwicklungen der Werbebranche. Eine 100 % klimaneutrale, europäische und nach Global Recycled Standard zertifizierte Produktion bilden die Basis für langlebiges und nachhaltiges Schreiben. Die neue Upcycling-Idee erweitert die bisher reine recycelte PET-Schreibgeräteserie um schicke Metallapplikationen. Aus einer recycelten Aluminium 150 ml Getränkedose entstehen 10 wertige Metallspitzen, die auf ein PET-Gehäuse einer recycelten 0,5 l PET-Flasche treffen. So schreiben Sie mit dem uma RECYCLED PET PEN PRO SI die nachhaltigste Kombination für die Umwelt – eben: uma Recycled².

RECYCLED PET PEN PRO SI Recycled² – the most sustainable combination in a writing instrument!

Recycled PET beverage bottles meet recycled aluminium beverage cans. The uma rPET PRO series is one of the most sustainable writing instrument developments in the promotional industry. A 100 % climate-neutral, European and Global Recycled Standard certified production built up the basics for long-lasting and sustainable writing. The new upcycling idea adds elegant metal applications to the previously pure recycled PET writing instrument series. A recycled aluminium 150 ml beverage can is recycled into 10 valuable metal tips that meet a PET housing of a recycled 0.5 l PET bottle. So with the uma RECYCLED PET PEN PRO SI you write the most sustainable combination for the environment – just: uma Recycled².

sustainable
RECYCLED²
INNOVATIVE



Produkt-Video / product video
RECYCLED PET PEN PRO SI

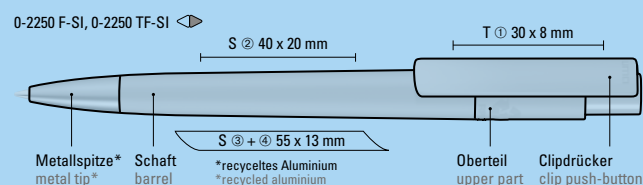

Farb-Code/Minen
Colour code/Refills

RECYCLED PET PEN PRO F SI
0-2250 F-SI

RECYCLED PET PEN PRO frozen SI
0-2250 TF-SI

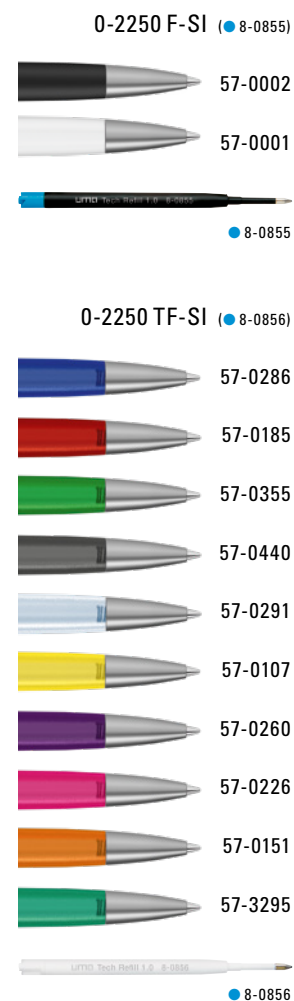

Die Gewinnung und Verarbeitung des rPET-Materials aus 100% recycelten PET-Flaschen sowie das rALU-Material aus 100% recycelten Aluminium-Getränkedosen findet in Europa statt. Die beiden Materialien eignen sich für einen langlebigen und nachhaltigen Werbeeinsatz. Dank der europäischen und klimaneutralen Produktion leistet der uma RECYCLED PET PEN PRO einen zusätzlichen nachhaltigen Beitrag zur Schonung der Umwelt. Aufgrund der Besonderheiten des Materials (recyceltes PET-Material) sind produktionstechnische Farbschwankungen gegeben.

The extraction and processing of the rPET material from 100% recycled PET bottles, as well as the rALU material from 100% recycled aluminium beverage cans takes place in Europe. Both materials are suitable for a durable and sustainable advertisement. Thanks to the European and climate-neutral production, the uma RECYCLED PET PEN PRO makes an additional sustainable contribution to the protection of the environment. Due to the special nature of the material (recycled PET material) production-related variations are possible.



Mix n' Match: Ab 2.000 Stück kann das Modell farblich kombiniert werden.

0-2250 F-SI: Druckkugelschreiber aus recyceltem PET-Material mit matt gedecktem Gehäuse und Clip sowie Metallspitze aus recyceltem Aluminium in silber matt.

0-2250 TF-SI: Druckkugelschreiber aus recyceltem PET-Material mit transparent gefrostetem Gehäuse und Clip sowie Metallspitze aus recyceltem Aluminium in silber matt.

Mindestbestellmenge
Werbeschlüssel

1.000 Stück
Schaft S, Clip T

Mix n' Match: From 2,000 pieces, you can choose any colour combination.

0-2250 F-SI: Retractable ballpoint pen made from recycled PET material with opaque matt housing and clip, metal tip made from recycled aluminium in matt silver.

0-2250 TF-SI: Retractable ballpoint pen made from recycled PET material with transparent frosted housing and clip, metal tip made from recycled aluminium in matt silver.

Minimum quantity
Advertising code

1,000 pieces
barrel S, clip T

RECYCLED PET PEN PRO ocean



made from ocean-bound plastic



Produkt-Video/
product video

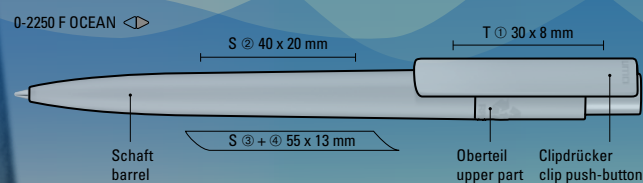

Farb-Code/Minen
Colour code/Refills

RECYCLED PET PEN PRO F ocean
0-2250 F OCEAN

0-2250 F OCEAN (● 8-0854)

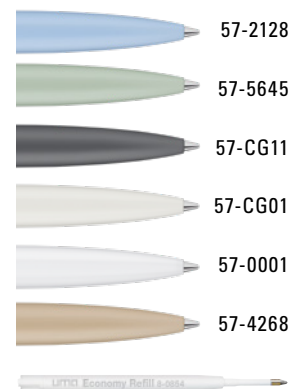

Etui Empfehlung / Case suggestion

ETUI 0-0940 CI

Informationen unter www.uma-pen.com
Information at www.uma-pen.com



Das durch Plastic Bank gesammelte Ocean Bound Plastic, auch bekannt als Social Plastic®, wird in Europa zu einem recycelten PET Schreibgerät für einen langlebigen und nachhaltigen Werbeeinsatz upgecycelt.

Dank der europäischen und klimaneutralen Produktion leistet der uma RECYCLED PET PEN PRO ocean einen zusätzlichen nachhaltigen Beitrag zur Schonung der Umwelt.

Ocean-bound plastic, also known as Social Plastic®, collected through Plastic Bank is upcycled in Europe into a recycled PET writing instrument for long-lasting and sustainable advertisement.

Thanks to the European and climate-neutral production, the uma RECYCLED PET PEN PRO ocean makes an additional sustainable contribution to the protection of the environment.



made from ocean-bound plastic



Mix n' Match: Ab 2.000 Stück kann das Modell farblich kombiniert werden.

0-2250 F OCEAN: Druckkugelschreiber aus recyceltem PET-Material aus Ocean Bound Plastic mit matt gedecktem Gehäuse und Clip.

Mindestbestellmenge
Werbeschlüssel

1.000 Stück
Schaft S, Clip T

Mix n' Match: From 2,000 pieces, you can choose any colour combination.

0-2250 F OCEAN: Retractable ballpoint pen made of ocean-bound PET material with opaque matt housing and clip.

Minimum quantity
Advertising code

1,000 pieces
barrel S, clip T



ANTIBAKTERIELL UND ANTIVIRAL

Der antimikrobielle Zusatz verleiht dem rPET eine antibakterielle und antivirale Wirkung.



Die antimikrobielle Wirkung ist für die gesamte Lebensdauer des Schreibgerätes gewährleistet und bietet somit einen dauerhaften Schutz.



GEPRÜFT UND ZERTIFIZIERT

Die Haftung und Ansiedelung von Krankheitserregern auf der Oberfläche des Schreibgerätes wird nachweislich zu 99,99% reduziert. Geprüft nach ISO 21702 (antiviral) und ISO 22196 (antibakteriell). Sowohl Bakterien als auch Viren (auch das Corona Virus) werden vernichtet.



MADE IN EUROPE

Kurze und schnelle Lieferwege ermöglichen eine zuverlässige und kurzfristige Produktion und schaffen einen zusätzlichen Beitrag zum Erhalt der Umwelt.



KLIMANEUTRAL

Die Schreibgeräte werden in Europa produziert und klimaneutral veredelt. Auf diese Weise wird ein zusätzlich positiver Beitrag für die Umwelt geleistet.



RECYCELTE

Das Gehäuse wird zu 100% aus recycelten PET-Flaschen hergestellt. Somit wurde bereits ein Recycling-Prozess umgesetzt und das Produkt kann wieder dem Recyclingzyklus zugeführt werden.

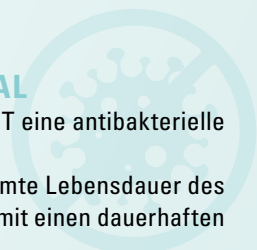

ANTIBACTERIAL AND ANTIVIRAL

It is made of antibacterial and antiviral plastic containing a special additive which releases silver ions that prevent bacteria from colonising the surface of the pen.



TESTED AND CERTIFIED

Laboratory tests have shown that up to 99.99% of bacteria and pathogens on the surface of writing instruments are eliminated. Tested according to ISO 21702 (antiviral) and ISO 22196 (antibacterial) effect is guaranteed for the entire life of the writing instrument and thus offers lasting protection.



MADE IN EUROPE

Short and fast delivery routes enable reliable and short-term production and create an additional contribution to the preservation to the environment.



CLIMATE NEUTRAL

The writing instruments are produced in Europe and finished climate neutral in the Black Forest. In this way, an additional positive contribution to the environment is made.



RECYCLED

The barrel is made of 100% recycled PET bottles. With the use of uma RECYCLED PET PENS we assure you that a recycling process has already been supported and that the writing instruments can be fed into further recycling cycles.



POS-Becher/Verpackungsoption
POS-Cup / transport packaging
0-2220 RECYCLED PET CUP
Informationen unter www.uma-pen.com
Information at www.uma-pen.com



Etui Empfehlung / Case suggestion
0-0940 CI ANTIBAC
Informationen unter www.uma-pen.com
Information at www.uma-pen.com

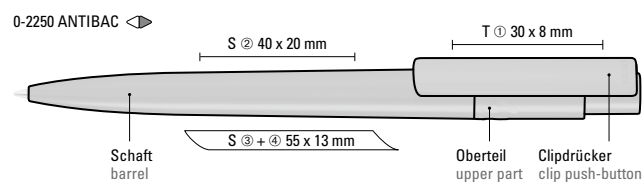

Farb-Code/Minen
Colour code/Refills

RECYCLED PET PEN PRO antibacterial
0-2250 ANTIBAC

- 0-2250 ANTIBAC (● 8-0854)
- 57-0298
- 57-0662
- 57-0200
- 57-7492
- 57-0361
- 57-0002
- 57-7527
- 57-0001
- 57-0012
- 57-0021
- 57-7710
- UMA Economy Refill 8-0854
- 8-0854

Wirkt gegen Corona - Viren



Hinweis auf dem Schaft aufgedruckt:
„antibacterial“ und „antiviral“
Note printed on the barrel
„antibacterial“ and „antiviral“

- ANTIBAKTERIELL
- ANTIVIRAL
- RECYCLT
- KLIMANEUTRAL

Das aus recycelten PET-Flaschen in Europa hergestellte rPET-Material eignet sich für langlebigen und nachhaltigen Werbeeinsatz. Der uma RECYCLED PET PEN PRO antibacterial bietet gleichzeitig mehrere Verkaufsargumente: recycelt, umweltverträglich, klimaneutral, antibakteriell und antiviral. Aufgrund der Besonderheiten des Materials (recyceltes PET-Material) sind produktionstechnische Farbschwankungen gegeben.

The rPET material, which is produced in Europe from recycled PET bottles, is suitable for a durable and sustainable advertisement. The uma RECYCLED PET PEN PRO antibacterial offers several sales arguments: recycled, environmentally friendly, climate-neutral, antibacterial and antiviral. Due to the special nature of the material (recycled PET material) production-related variations are possible.



Mix n' Match: Ab 2.000 Stück kann das Modell farblich kombiniert werden.

0-2250 ANTIBAC: Druckkugelschreiber aus recyceltem, antibakteriellem und antiviralem rPET in gedeckt glänzendem Gehäuse und Clip. Der nach ISO 22196 und ISO 21702 geprüfte antimikrobielle Zusatz verleiht dem rPET eine antibakterielle und antivirale Wirkung auch gegen Corona-Viren. Die Haftung und Ansiedlung von Bakterien oder Krankheitserregern auf der Oberfläche des Schreibgerätes wird um 99,99% verringert. Der in das rPET Material eingearbeitete antimikrobielle Zusatz kann nicht abgerieben oder abgegeben werden und wirkt über die gesamte Lebensdauer des Schreibgerätes. Eine dauerhafte Reduzierung von Krankheitserregern ist gegeben.

Mindestbestellmenge
Werbeschlüssel

1.000 Stück
Schaft S, Clip T

Mix n' Match: From 2,000 pieces, you can choose any colour combination.

0-2250 ANTIBAC: Retractable ballpoint pen made from recycled, antibacterial and antiviral recycled PET material with opaque glossy housing and clip. The ISO 22196 and ISO 21702 tested antimicrobial additive of silver ions gives the rPET material an antibacterial and antiviral effect that reduces the adhesion and settling of bacteria or pathogens on the surface of the writing instrument by 99.99%. The antimicrobial additive incorporated into the rPET material cannot be rubbed off or released and is effective over the entire life of the writing instrument. A permanent reduction of pathogens is given.

Minimum quantity
Advertising code

1,000 pieces
barrel S, clip T

Farb-Code/Minen
Colour code/Refills

RECYCLED PET PEN PRO F TOUCH
0-2250 F TO

0-2250 F TO (● 8-0854)



Das aus recycelten PET-Flaschen in Europa hergestellte rPET-Material eignet sich für einen langlebigen und nachhaltigen Werbeeinsatz. Dank der europäischen und klimaneutralen Produktion leistet der uma RECYCLED PET PEN PRO F TOUCH einen zusätzlichen nachhaltigen Beitrag zur Schonung der Umwelt.

Aufgrund der Besonderheiten des Materials (recyceltes PET-Material) sind produktionstechnische Farbschwankungen gegeben.

The rPET material, which is produced in Europe from recycled PET bottles, is suitable for a durable and sustainable advertisement. Thanks to the European and climate-neutral production, the uma RECYCLED PET PEN PRO F TOUCH makes an additional sustainable contribution to the protection of the environment.

Due to the special nature of the material (recycled PET material) production-related variations are possible.

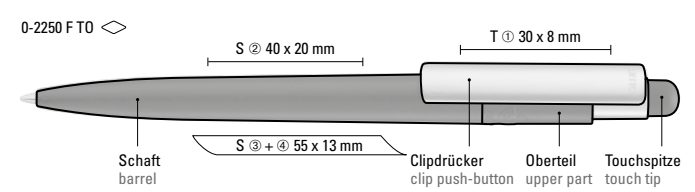

0-2250 F TO: Druckkugelschreiber aus recyceltem PET-Material mit matt gedecktem Gehäuse und silbernem Clip, Drücker mit integrierter Touchscreensteuerung.

Mindestbestellmenge
Werbeschlüssel

1.000 Stück
Schaft S, Clip T

0-2250 F TO: Retractable ballpoint pen made from recycled PET material with opaque matt housing and silver clip, push-button with integrated touch screen control.

Minimum quantity
Advertising code

1,000 pieces
barrel S, clip T



RECYCLED PET PEN ALUMA



Die Gewinnung und Verarbeitung des rPET Materials aus 100% recycelten PET-Flaschen sowie das rALU-Material aus 100% recycelten Aluminium-Getränkedosen findet in Europa statt. Die beiden Materialien eignen sich für einen langlebigen und nachhaltigen Werbeeinsatz. Dank der europäischen und klimaneutralen Produktion leistet der uma RECYCLED PET PEN ALUMA transparent einen zusätzlichen nachhaltigen Beitrag zur Schonung der Umwelt. Aufgrund der Besonderheiten des Materials (recyceltes PET-Material) sind produktionstechnische Farbschwankungen gegeben.

The extraction and processing of the rPET material from 100% recycled PET bottles, as well as the rALU material from 100% recycled aluminium beverage cans takes place in Europe. Both materials are suitable for a durable and sustainable advertisement. Thanks to the European and climate-neutral production, the uma RECYCLED PET PEN ALUMA makes an additional sustainable contribution to the protection of the environment.

Due to the special nature of the material (recycled PET material) production-related variations are possible.

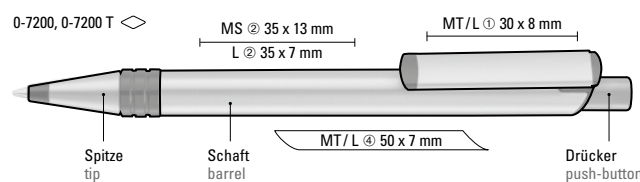

Farb-Code/Minen
Colour code/Refills

RECYCLED PET PEN ALUMA
0-7200

RECYCLED PET PEN ALUMA transparent
0-7200 T

- 0-7200 (● 8-0855)
- 0-7200 T (● 8-0856)
- 57-0298
- 57-0662
- 57-0200
- 57-7492
- 57-0361
- 57-0340
- 57-0002
- 57-7527
- 57-0001
- 57-0012
- 57-0270
- 57-2607
- 57-0233
- 57-0021
- 57-7710
- 57-7500
- UMA Tech Refill 1.0 - 8-0855
- UMA Tech Refill 1.0 - 8-0856



Die Modelle eignen sich für eine Laserung in weiß.
The models are suitable for laser engraving in white.



0-7200: Metall-Druckkugelschreiber mit Metallspitze, Metallschaft und Metallclip aus recyceltem Aluminium, Kunststoffteile aus recyceltem PET-Material in gedeckt schwarz und gedeckt farbigem Drücker.

0-7200 T: Metall-Druckkugelschreiber mit Metallspitze, Metallschaft und Metallclip aus recyceltem Aluminium, Kunststoffteile aus recyceltem PET-Material in klar transparent und gedeckt farbigem Drücker.

Mindestbestellmenge
Werbeschlüssel

300 Stück
Schaft MS/MT/L, Clip MT/L

0-7200: Metal retractable ballpoint pen with metal tip, metal barrel and metal clip made from recycled aluminium in matt silver, plastic parts made from recycled PET material in opaque glossy black and opaque coloured push-button.

0-7200 T: Metal retractable ballpoint pen with metal tip, metal barrel and metal clip made from recycled aluminium in matt silver, plastic parts made from recycled PET material in opaque clear transparent and opaque coloured push-button.

Minimum quantity
Advertising code

300 pieces
barrel MS/MT/L, clip MT/L



rABS – recycler Kunststoff

Recycler ABS-Kunststoff wird aus den **Spritzgussresten** der eigenen Spritzgießerei gewonnen. Hierzu werden die Kunststoffabfälle gesammelt und dem Spritzgussprozess wieder zugeführt. Die gesammelten Kunststoffe können sortenrein und qualitätsbestimmt gesammelt werden. Durch das Aufbereiten der Kunststoffe kann aus diesen ein recyceltes Produkt gefertigt werden. Generell wird durch das Recyclen der Kunststoffe weniger Rohöl und Energie verbraucht.

rABS – recycled plastic

Recycled ABS plastic is obtained from the **injection moulding** debris from our own injection moulding plant. For this, plastic waste is collected up and directed back into the injection moulding process. The collected plastics can be collected, graded and grouped by quality standard. These preparatory operations with plastics are the key to manufacturing a recycled product. Without exception, the recycling of plastics uses less crude oil and power.

Das Gehäuse des HAPPY RECY wird aus recyceltem ABS Kunststoff hergestellt und ist mit dem rABS Logo gekennzeichnet.

The housing of the HAPPY RECY is made of recycled plastics (ABS) and is marked with the rABS logo.

HAPPY RECY
0-0037 RECY

rPCP – recycler Kunststoff

Recycler Post-Consumer-Kunststoff (PCP) wird meist aus technischen (Haushalts-) Geräten oder sonstigen **Consumer Kunststoffabfällen** gewonnen. Hierzu werden die Kunststoffe gesammelt und sortenrein recycelt. Die sogenannten Post Consumer oder Post Industry Kunststoffe können nach der Aufbereitung in ein neues Produkt upgecycelt werden. Generell wird durch das Recyclen der Kunststoffe weniger Rohöl und Energie verbraucht.

rPCP – recycled plastic

For the most part, recycled post-consumer plastic (PCP) is obtained from technical (domestic) appliances or other forms of **plastic consumer waste**. This process involves collecting and grading plastics and recycling each grade separately. After the recycling process, a new product can be 'upcycled' from what are known as post-consumer or also post industry plastics. Without exception, the recycling of plastics uses less crude oil and power.

Das Gehäuse des VANE RECY wird aus recyceltem Post-Consumer-Kunststoff (PCP) hergestellt und ist mit dem POST-CONSUMER-RECYCLED-PLASTIC-Logo gekennzeichnet.

The housing of the VANE RECY is made of recycled Post-Consumer plastics (PCP) and is marked with the POST-CONSUMER RECYCLED PLASTIC logo.

VANE RECY
0-0183 RECY



0-0092 RECY (● 8-0854)



0-0037 RECY (● 8-0865)

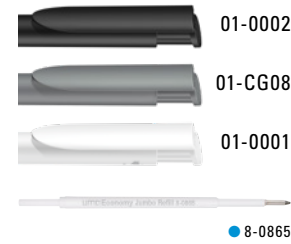

Das Gehäuse des YES RECY wird aus recyceltem ABS-Kunststoff hergestellt und ist mit dem rABS Logo gekennzeichnet.
The housing of the YES RECY is made of recycled plastics (ABS) and is labelled with the rABS logo.



Das Gehäuse des HAPPY RECY wird aus recyceltem ABS-Kunststoff hergestellt und ist mit dem rABS Logo gekennzeichnet.
The housing of the HAPPY RECY is made of recycled plastics (ABS) and is labelled with the rABS logo.

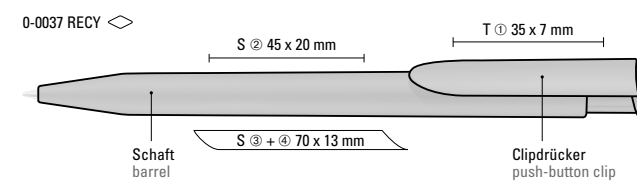
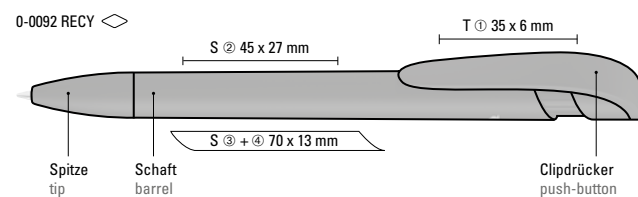

0-0092 RECY: Druckkugelschreiber mit gedeckt mattem Gehäuse, breitem Bogenclipdrücker und Spitze aus recyceltem Kunststoff. Das Modell ist mit dem Recyclingzeichen gekennzeichnet. Aufgrund der Besonderheit des Materials (ABS Recycled Plastic) sind produktionstechnische Farbschwankungen gegeben.

Mindestbestellmenge 1.000 Stück
Werbeschlüssel Schaft S ○, Clip T

0-0092 RECY: Retractable ballpoint pen with opaque matt housing, wide curved clip button and tip made from recycled plastic. The model is labelled with the recycling mark. Due to the special nature of the material (ABS recycled plastic) colour variations may occur during the production process.

Minimum quantity 1,000 pieces
Advertising code Schaft S ○, clip T

0-0037 RECY: Druckkugelschreiber mit gedeckt mattem Gehäuse und Clipdrücker aus recyceltem Kunststoff. Das Modell ist mit dem Recyclingzeichen gekennzeichnet. Aufgrund der Besonderheit des Materials (ABS Recycled Plastic) sind produktionstechnische Farbschwankungen gegeben.

Mindestbestellmenge 1.000 Stück
Werbeschlüssel Schaft S ○, Clip T

0-0037 RECY: Retractable ballpoint pen with opaque matt housing and clip button made of recycled plastic. The model is labelled with the recycling mark. Due to the special nature of the material (ABS recycled plastic) colour variations may occur during the production process.

Minimum quantity 1,000 pieces
Advertising code Schaft S ○, clip T

Farb-Code/Minen
Colour code/Refills

VANE RECY
0-0183 RECY



Klimaneutral
Schreibgerät
ClimatePartner.com/13223-2104-1001

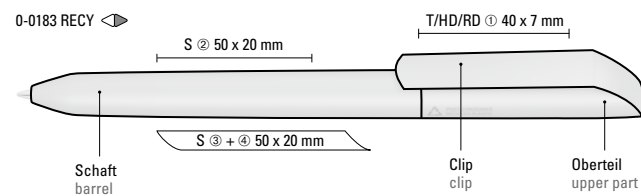

Mix n' Match: Ab 2.000 Stück kann das Modell farblich kombiniert werden.

0-0183 RECY: Drehkugelschreiber mit gedeckt mattem Gehäuse und Clip aus 100% recyceltem Post-Consumer-Kunststoff. Das Modell ist mit dem Recyclingzeichen gekennzeichnet. Aufgrund der Besonderheit des Materials (Post-Consumer Recycled Plastic) sind produktionstechnische Farbschwankungen gegeben.

Mindestbestellmenge
Werbeschlüssel

1.000 Stück
Schaft S, Clip T/HD/RD

Mix n' Match: From 2,000 pieces, you can choose any colour combination.

0-0183 RECY: Twist ballpoint pen with opaque matt housing and clip made from 100% recycled post-consumer plastic. The model is labelled with the recycling mark. Due to the special nature of the material (post-consumer recycled plastic) colour variations may occur during the production process.

Minimum quantity
Advertising code

1,000 pieces
barrel S, clip T/HD/RD



0-0063 RECY (● 8-0866)	Drücker/Stopfen ABS push-button/plug ABS
32-0534	32-0292
32-0350	32-2175
32-0432	32-2147
32-0425	32-0200
32-0428	32-0382
32-0001	32-0348
32-0466	32-0343
32-7532	32-0002
● 8-0866	32-0428
	32-0001
	32-0115
	32-2705
	32-2685
	32-0188
	32-0203
	32-0213
	32-1585
	32-0638
	32-3262
	32-0321
	32-0468
	32-7569
	32-0469

0-0063 RECY:
Drücker und Stopfen sind ab 2.000 Stück auch in allen glänzend gedeckten ABS Standardfarben erhältlich.
0-0063 RECY:
From 2,000 units, push-buttons and plugs are available in all solid shiny ABS standard colours.

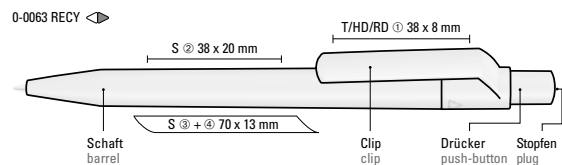

Mix n' Match: Ab 2.000 Stück kann das Modell farblich kombiniert werden.

0-0063 RECY: Druckkugelschreiber mit gedeckt mattem Gehäuse, Clip, Drücker und Stopfen aus 100% recyceltem Post-Consumer-Kunststoff. Das Modell ist mit dem Recyclingzeichen gekennzeichnet. Drücker und Stopfen optional in verschiedenen gedeckt glänzenden Farben (Standard ABS) erhältlich. Aufgrund der Besonderheit des Materials (Post-Consumer Recycled Plastic) sind produktionstechnische Farbschwankungen gegeben.

Mindestbestellmenge 1.000 Stück
Werbeschlüssel Schaft S, Clip T/HD/RD

Mix n' Match: From 2,000 pieces, you can choose any colour combination.

0-0063 RECY: Retractable ballpoint pen with opaque matt housing, clip, push-button and plug made of 100% recycled post-consumer plastic. The model is labelled with the recycling mark. Push-buttons and plugs optionally available in various opaque glossy colours (standard ABS). Due to the special nature of the material (post-consumer recycled plastic) colour variations may occur during the production process.

Minimum quantity 1,000 pieces
Advertising code barrel S, clip T/HD/RD

Drücker ABS push-button ABS	0-0017 RECY (● 8-0866)
32-2175	32-0534
32-2147	32-0350
32-0200	32-0432
32-0348	32-0425
32-0343	32-0428
32-0002	32-0001
32-0001	32-0466
32-0468	32-7532
32-0115	● 8-0866
32-1585	
32-0188	



0-0017 RECY:
Drücker sind ab 2.000 Stück auch in allen glänzend gedeckten ABS Standardfarben erhältlich.
0-0017 RECY:
From 2,000 units, plugs are available in all solid shiny ABS standard colours.

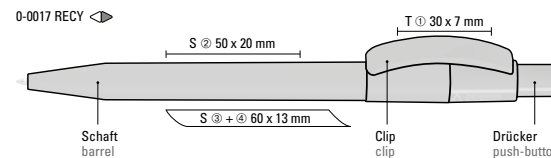

Mix n' Match: Ab 2.000 Stück kann das Modell farblich kombiniert werden.

0-0017 RECY: Druckkugelschreiber mit gedeckt mattem Kunststoffgehäuse aus 100% recyceltem Post-Consumer-Kunststoff, glänzendem Bogenclip und Drücker. Das Modell ist mit dem Recyclingzeichen gekennzeichnet. Drücker optional in verschiedenen gedeckt glänzenden Farben (Standard ABS) erhältlich. Aufgrund der Besonderheit des Materials (Post-Consumer Recycled Plastic) sind produktionstechnische Farbschwankungen gegeben.

Mindestbestellmenge 1.000 Stück
Werbeschlüssel Schaft S, Clip T

Mix n' Match: From 2,000 pieces, you can choose any colour combination.

0-0017 RECY: Retractable ballpoint pen with matt plastic housing made from 100% recycled post-consumer plastic, opaque glossy curved clip and push-button. The model is labelled with the recycling mark. Push-buttons available in various opaque glossy colours (standard ABS). Due to the special nature of the material (post-consumer recycled plastic) colour variations may occur during the production process.

Minimum quantity 1,000 pieces
Advertising code barrel S, clip T





Farb-Code/Minen
Colour code/Refills

TREE
5-5400

LEAF
5-5900

- 5-5400 (● 8-0877)
- 08-W001
- 8-0877
- 5-5900 (● 8-0855)
- 37-W001
- 8-0855



Das Zeichen für verantwortungsvolle Waldwirtschaft

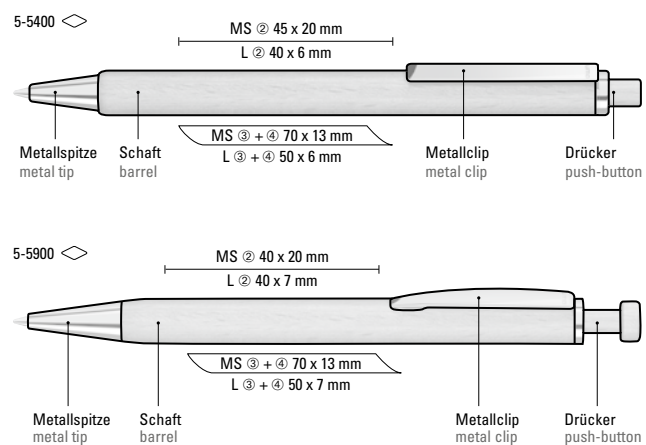

Der Naturstoff Holz variiert sowohl in der Farbigkeit des Holzes als auch in der Struktur (Maserung).

Wood is a natural material with a great variety of colours and textures (grain effect).

5-5400: Holz-Druckkugelschreiber mit Holzdrücker, Metallclip und Metallspitze glanzverchromt. Schaft und Drücker aus schutzlackiertem PEFC-zertifiziertem Buchenholz.

5-5900: Holz-Druckkugelschreiber mit Holzdrücker, Metallclip und Metallspitze glanzverchromt. Schaft und Drücker aus schutzlackiertem FSC®-zertifiziertem Buchenholz.

Mindestbestellmenge
Werbeschlüssel

300 Stück
Schaft MS/L

5-5400: Wooden retractable ballpoint pen with wooden push-button, metal clip and metal tip chrome plated. Barrel and push-button made from PEFC certified beechwood with protective varnish coating.

5-5900: Wooden retractable ballpoint pen with wooden push-button, metal clip and metal tip chrome plated. Barrel and push-button made from FSC® certified beechwood with protective varnish coating.

Minimum quantity
Advertising code

300 pieces
barrel MS/L



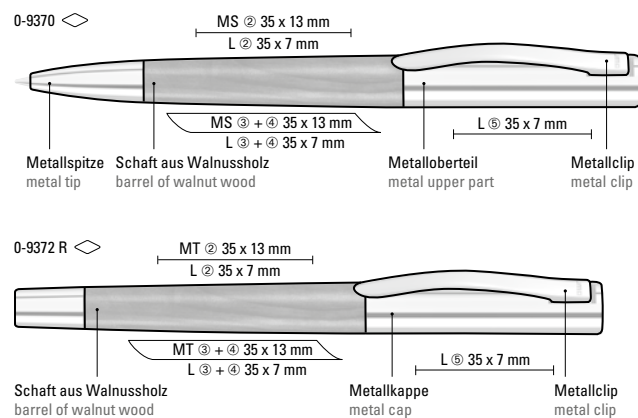

Farb-Code/Minen
Colour code/Refills

TITAN WOOD
0-9370

TITAN WOOD R
0-9372 R

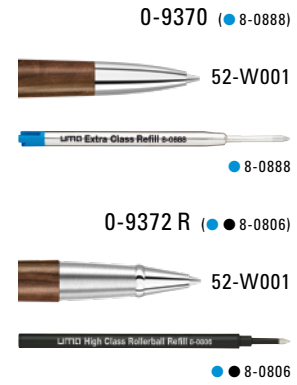

Der Naturstoff Holz variiert sowohl in der Farbigkeit des Holzes als auch in der Struktur (Maserung).

Wood is a natural material with a great variety of colours and textures (grain effect).



Etui Empfehlung / Case suggestion
ETUI 0-0944

Informationen unter www.uma-pen.com
Information at www.uma-pen.com

0-9370: Metall-Drehkugelschreiber mit Schaft aus FSC®-zertifiziertem Walnussholz, Softdrehmechanik und gefedertem Clip. Oberteil, Clip und Spitze glanzverchromt.

0-9372 R: Metall-Rollerball mit Schaft aus FSC®-zertifiziertem Walnussholz und gefedertem Clip. Kappe und Clip glanzverchromt.

0-9370
Mindestbestellmenge
Werbeschlüssel

0-9372 R
Mindestbestellmenge
Werbeschlüssel

100 Stück
Schaft MS/L, Oberteil L

100 Stück
Schaft MT/L, Kappe L

0-9370: Metal twist ballpoint pen with barrel made from FSC® certified walnut wood, soft twist mechanism and spring-mounted clip. Upper part, clip and tip glossy chrome plated.

0-9372 R: Metal roller ball with barrel made from FSC® certified walnut wood, spring-mounted clip. Cap and clip glossy chrome plated.

0-9370
Minimum quantity
Advertising code

0-9372 R
Minimum quantity
Advertising code

100 pieces
barrel MS/L, upper part L

100 pieces
barrel MT/L, cap L



Farb-Code/Minen
Colour code/Refills

ELEGANCE WOOD
0-9190 WOOD

0-9190 WOOD (● 8-0888)



Das Zeichen für verantwortungsvolle Waldbirtschaft



Der Naturstoff Holz variiert sowohl in der Farbigkeit des Holzes als auch in der Struktur (Maserung).

Wood is a natural material with a great variety of colours and textures (grain effect).

0-9190 WOOD: Metall-Drehkugelschreiber mit Schaft aus FSC®-zertifiziertem Walnussholz, gefederter Metallclip, Metallstopfen, schwere Metallspitze matt verchromt und Softdrehmechanik.

Mindestbestellmenge
Werbeschlüssel

100 Stück
Schaft MS/L, Stopfen L

0-9190 WOOD: Metal twist ballpoint pen with FSC® certified walnut barrel, spring-mounted metal clip, plug, metal tip matt chrome plated and soft twist mechanism.

Minimum quantity
Advertising code

100 pieces
barrel MS/L, plug L

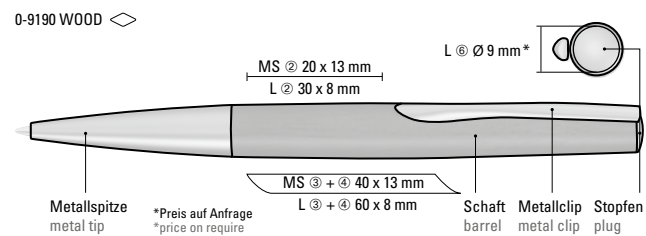

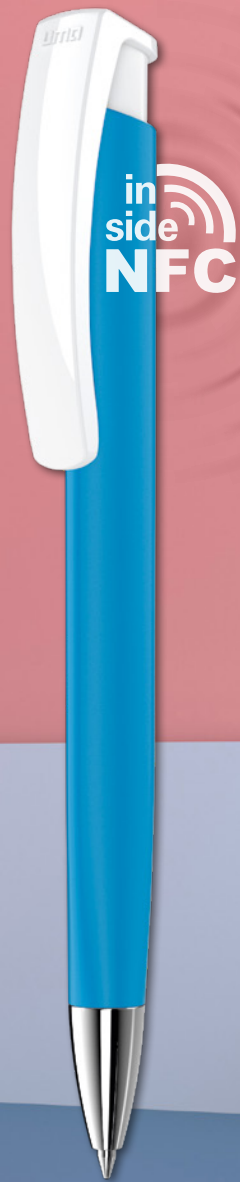

NFC

Verbinden Sie analoges Schreiben und Werben mittels NFC-Technik mit der interaktiven Welt. Transportieren Sie mit den integrierten uma NFC TAGS nicht mehr nur haptische Werbung, sondern digitale Informationen. Egal ob Kontaktdaten, BusinessCard, Videobotschaften, Produkt- oder Imagefilme, Webseiten oder Social Media Seiten, Verkaufsunterlagen wie Produktkataloge u.v.m.

Connect analogue writing and advertising with the interactive world using NFC technology. With the integrated uma NFC TAGS, go beyond haptic advertising and transmit digital information. Perfect for contact details, BusinessCards, video messages, product or image films, website or social media pages, sales documentation such as product catalogues, etc.

Farb-Code/Minen
Colour code/Refills

TRINITY GUM
0-0133 GUM

TRINITY SI GUM
0-0133 SI GUM

TRINITY KG SI GUM
0-0133 KG-SI GUM

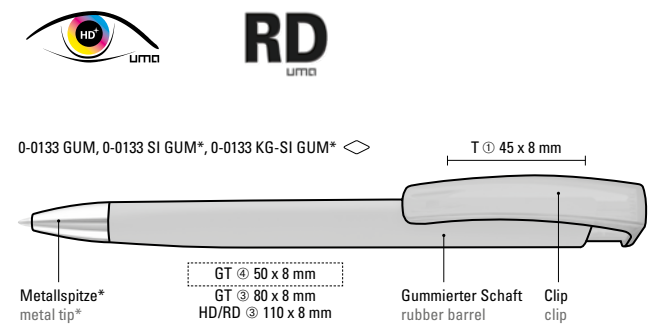
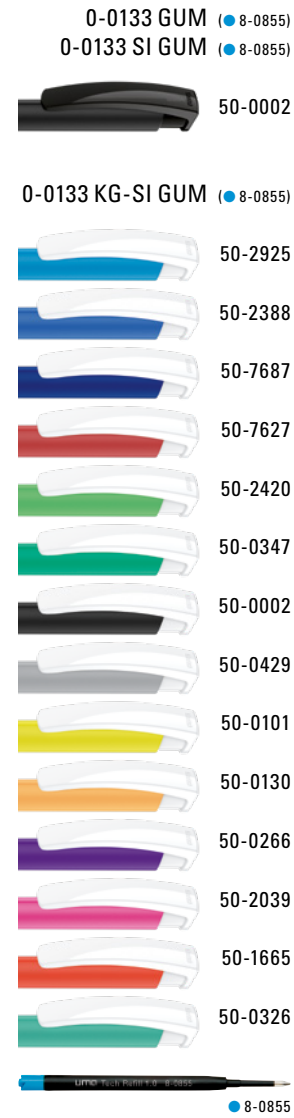

0-0133 GUM: Druckkugelschreiber mit gummiertem Dreikantgehäuse und gedeckt glänzendem Clip.

0-0133 SI GUM: Druckkugelschreiber mit gummiertem Dreikantgehäuse, gedeckt glänzendem Clip und schwerer Metallspitze glanzverchromt.

0-0133 KG-SI GUM: Druckkugelschreiber mit gummiertem Dreikantgehäuse, weiß gedeckt glänzendem Clip und schwerer Metallspitze glanzverchromt.

Mindestbestellmenge
Werbeschlüssel

1.000 Stück
Schaft GT/HD/RD, Clip T

0-0133 GUM: Retractable ballpoint pen with softtouch triangular housing and opaque glossy clip.

0-0133 SI GUM: Retractable ballpoint pen with softtouch triangular housing, opaque glossy clip and heavy metal tip chrome plated.

0-0133 KG-SI GUM: Retractable ballpoint pen with softtouch triangular housing, opaque glossy clip in white and heavy metal tip chrome plated.

Minimum quantity
Advertising code

1,000 pieces
barrel GT/HD/RD, clip T

uma Quick Response

Verbinden Sie schnell die haptische, analoge Werbung mit der digitalen Welt. Mittels einem einfachen **uma QR-Code Print** können Sie mit den uma Schreibgeräten einen zusätzlichen Kommunikationskanal öffnen. Über den **QR-Code Scan** gelangen die User schnell auf eine vom Kunden definierte Landingpage. So wird schnelle und messbare Response geschaffen, die durch das Schreibgerät angetrieben wird.

Der **uma QR-Code Print** kann auf verschiedenen Modellen in verschiedenen Positionen und auch mittels verschiedener Drucktechniken bis hin zur Lasertechnik umgesetzt werden.

It's never been easier to connect haptic, analogue marketing to the digital world. All made possible thanks to a simple, **uma QR Code Print**. Gain a new communication channel with your uma pens. Users just need to scan the **QR** code to quickly access the defined landing page. Achieve quick and measurable responses driven by pens.



uma QR codes can be printed in a range of positions on various models using several available printing methods, including laser technology.



Farb-Code/Minen
Colour code/Refills

TRINITY K TRANSPARENT GUM
0-0133 KT GUM

TRINITY K transparent SI GUM
0-0133 KT-SI GUM

- 0-0133 KT GUM (● 8-0855)
- 0-0133 KT-SI GUM (● 8-0855)
-  50-2925
-  50-2388
-  50-7687
-  50-7627
-  50-2420
-  50-0347
-  50-0002
-  50-0429
-  50-0101
-  50-0130
-  50-0266
-  50-2039
-  50-1665
-  50-0326
-  8-0855

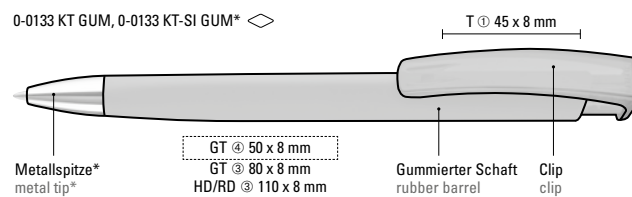

0-0133 KT GUM: Druckkugelschreiber mit gummiertem Dreikantgehäuse und transparent glänzendem Clip.

0-0133 KT-SI GUM: Druckkugelschreiber mit gummiertem Dreikantgehäuse, transparent glänzendem Clip und schwerer Metallspitze glanzverchromt.

Mindestbestellmenge
Werbeschlüssel

1.000 Stück
Schaft GT/HD/RD, Clip T

0-0133 KT GUM: Retractable ballpoint pen with softtouch triangular housing and transparent clip.

0-0133 KT-SI GUM: Retractable ballpoint pen with softtouch triangular housing, transparent clip and heavy metal tip chrome plated.

Minimum quantity
Advertising code

1,000 pieces
barrel GT/HD/RD, clip T





Farb-Code/Minen
Colour code/Refills

CORAL GUM
0-0177 GUM

0-0177 GUM (● 8-0855)

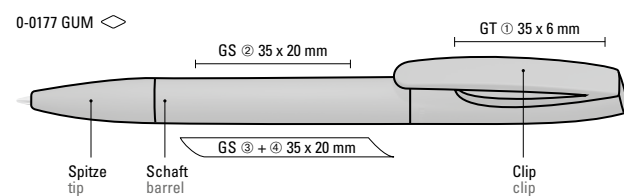
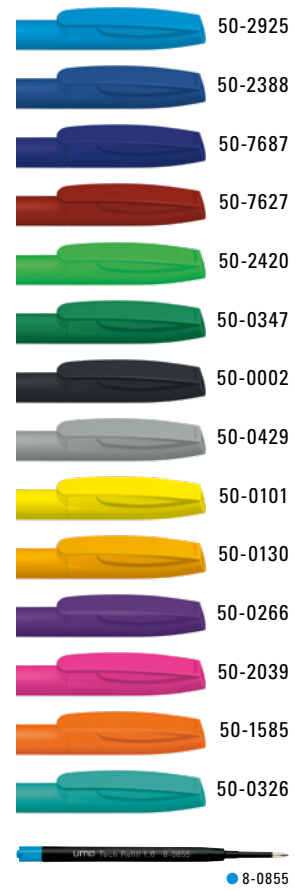

0-0177 GUM: Drehkugelschreiber mit Softtouch-Gehäuse und Softtouch-Clip.

Mindestbestellmenge
Werbeschlüssel

1.000 Stück
Schaft GS, Clip GT

0-0177 GUM: Twist ballpoint pen with softtouch housing and softtouch clip.

Minimum quantity
Advertising code

1,000 pieces
barrel GS, clip GT



Farb-Code/Minen Colour code/Refills	CORAL SI 0-0177 SI	CORAL frozen SI 0-0177 TF-SI	CORAL 0-0177	CORAL frozen 0-0177 TF
0-0177 SI (● 8-0855) 0-0177 TF-SI (● 8-0856) 0-0177 (● 8-0855) 0-0177 TF (● 8-0856)				
50-2925 50-2925 50-0301 50-0072 50-0280 50-1795 50-7621 50-2271 50-2420 50-0356 50-0340 50-0405 50-0002 50-0003 50-CG08 50-0396 50-0001 50-0130 50-0115 50-2077 50-2597 50-0214 50-0233 50-1585 50-1585 50-0326 50-0326 8-0856 8-0855				

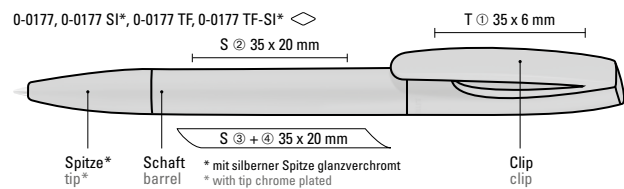

0-0177 SI: Drehkugelschreiber mit matt gedecktem Gehäuse und silberner Spitze glanzverchromt.
 0-0177 TF-SI: Drehkugelschreiber mit transparent gefrostetem Gehäuse und silberner Spitze glanzverchromt.
 0-0177: Drehkugelschreiber mit matt gedecktem Gehäuse.
 0-0177 TF: Drehkugelschreiber mit transparent gefrostetem Gehäuse.
 Mindestbestellmenge 1.000 Stück
 Werbeschlüssel Schaft S, Clip T

0-0177 SI: Twist ballpoint pen with opaque matt housing and tip chrome plated.
 0-0177 TF-SI: Twist ballpoint pen with transparent frosted housing and tip chrome plated.
 0-0177: Twist ballpoint pen with opaque matt housing.
 0-0177 TF: Twist ballpoint pen with transparent frosted housing.
 Minimum quantity 1,000 pieces
 Advertising code barrel S, clip T

Farb-Code/Minen
Colour code/Refills

HAPPY
0-0037

HAPPY frozen
0-0037 TF

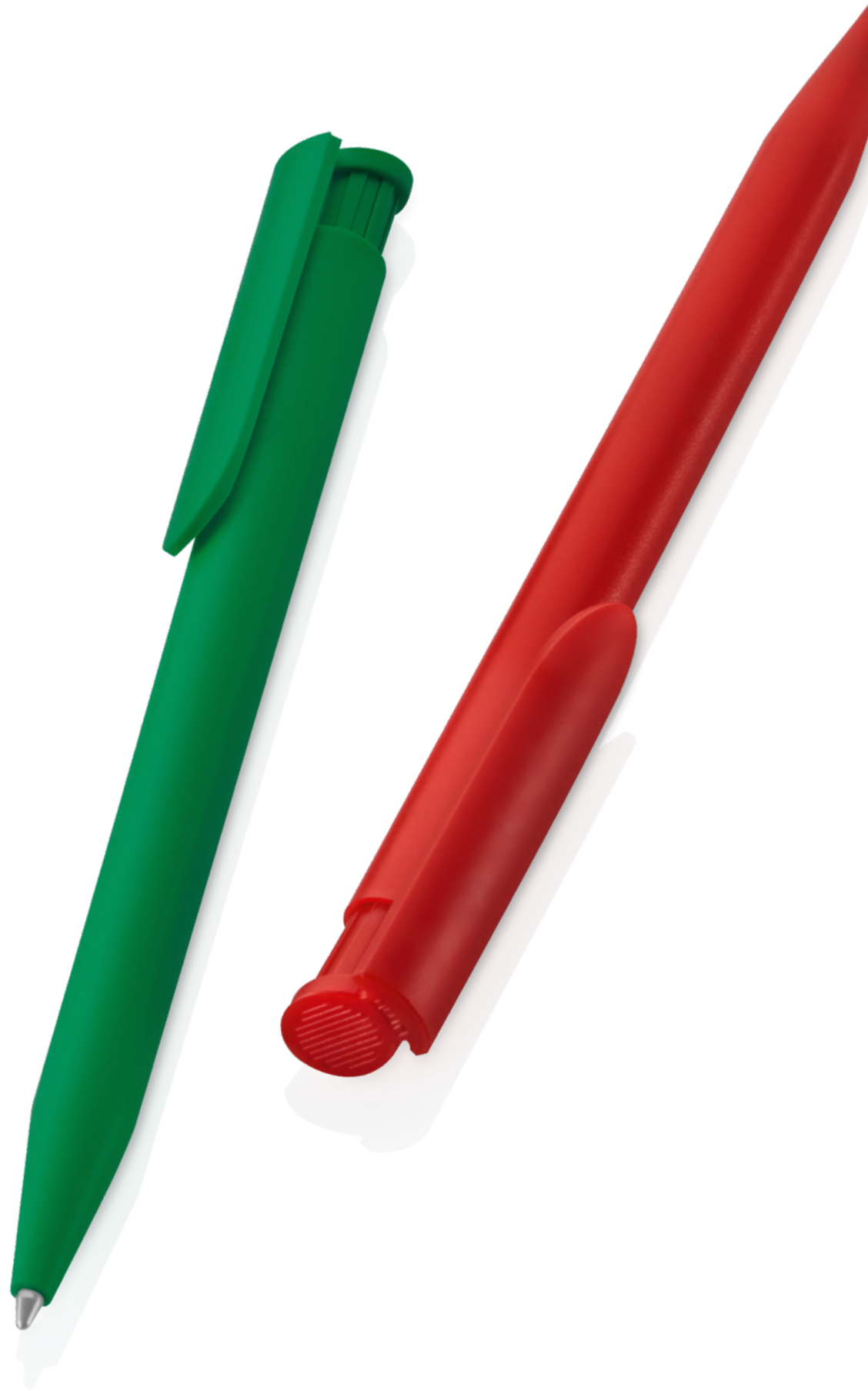

0-0037 (● 8-0865)		0-0037 TF (● 8-0865)	
	20-2925		20-2925
	20-0301		20-0072
	20-0280		20-1795
	20-7621		20-2271
	20-2420		20-0356
	20-0340		20-0405
	20-0002		20-0003
	20-CG08		20-0396
	20-0001		20-0130
	20-0115		20-2077
	20-2597		20-0214
	20-0233		20-1585
	20-1585		20-0326
	20-0326		

● 8-0865



UMA PRIME



UMA PRIME

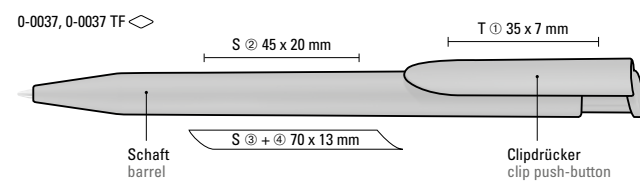

0-0037: Druckkugelschreiber mit gedeckt mattem Gehäuse und Clipdrücker.

0-0037 TF: Druckkugelschreiber mit transparent gefrostetem Gehäuse und Clipdrücker.

Mindestbestellmenge
Werbeschlüssel

1.000 Stück
Schaft S ○, Clip T

0-0037: Retractable ballpoint pen with opaque matt housing and clip button.

0-0037 TF: Retractable ballpoint pen with transparent frosted housing and clip button.

Minimum quantity
Advertising code

1,000 pieces
barrel S ○, clip T



Farb-Code/Minen
Colour code/Refills

SKY M SI GUM
0-0125 M-SI GUM

SKY GUM
0-0125 GUM

- 0-0125 M-SI GUM (● 8-0855)
- 0-0125 GUM (● 8-0855)
- 50-2925
- 50-2388
- 50-7687
- 50-7627
- 50-2420
- 50-0347
- 50-0002
- 50-0429
- 50-0101
- 50-0130
- 50-0266
- 50-2039
- 50-1665
- 50-0326
- UMA TECH BALLPOINT 0-0855 (● 8-0855)



UMA
PRIME



UMA
PRIME

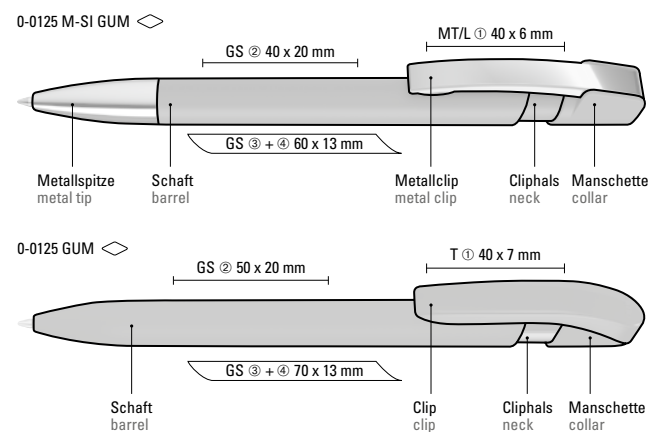

0-0125 M-SI GUM: Druckkugelschreiber mit Softtouch-Gehäuse, flexiblem Metallclip und schwerer Metallspitze glanzverchromt.

0-0125 GUM: Druckkugelschreiber mit Softtouch-Gehäuse und Manschette, Clip und Cliphals gedeckt glänzend.

0-0125 M-SI GUM
Mindestbestellmenge
Werbeschlüssel

1.000 Stück
Schaft GS, Clip MT/L

0-0125 GUM
Mindestbestellmenge
Werbeschlüssel

1.000 Stück
Schaft GS, Clip T

0-0125 M-SI GUM: Retractable ballpoint pen with softtouch housing, flexible metal clip and heavy metal tip chrome plated.

0-0125 GUM: Retractable ballpoint pen with softtouch housing and collar, opaque glossy clip and neck.

0-0125 M-SI GUM
Minimum quantity
Advertising code

1,000 pieces
barrel GS, clip MT/L

0-0125 GUM
Minimum quantity
Advertising code

1,000 pieces
barrel GS, clip T

Farb-Code/Minen
Colour code/Refills

STREAM
0-0151

STREAM M SI
0-0151 M-SI



0-0151 (● 8-0855)	0-0151 M-SI (● 8-0855)
50-0002	50-2925
50-0001	50-0301
0-0151: Farben Drücker 0-0151: push-button colours	50-0280
50-2925	50-7621
50-0301	50-2420
50-0280	50-0340
50-7621	50-0002
50-2420	50-CG08
50-0340	50-0001
50-0002	50-0115
50-CG08	50-0137
50-0001	50-2597
50-0115	50-0233
50-0137	50-1665
50-2597	50-0326
50-0233	
50-1665	
50-0326	

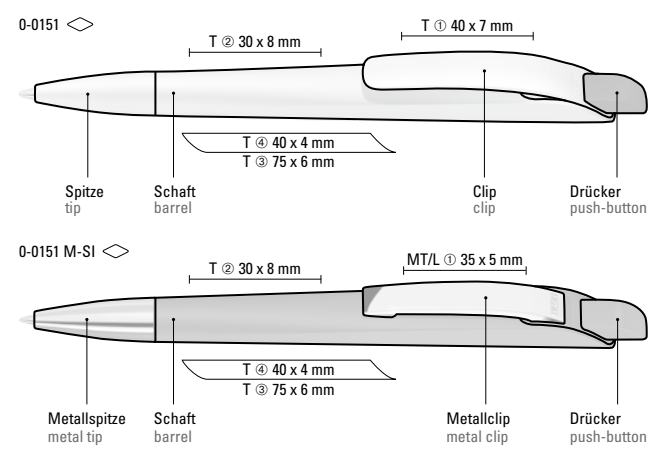

0-0151: Druckkugelschreiber mit geometrisch wechselnder Schaftform. Gehäuse gedeckt matt schwarz oder weiß mit Bogenclip und farbigem Drücker.

0-0151 M-SI: Druckkugelschreiber mit geometrisch wechselnder Schaftform. Gehäuse und Drücker gedeckt matt, Metallclip und Metallspitze glanzverchromt.

0-0151
Mindestbestellmenge
Werbeschlüssel

0-0151 M-SI
Mindestbestellmenge
Werbeschlüssel

1.000 Stück
Schaft T, Clip T

1.000 Stück
Schaft T, Clip MT/L

0-0151: Retractable ballpoint pen with geometric changes in the barrel. Opaque matt housing in black or white with curved clip and coloured push-button.

0-0151 M-SI: Retractable ballpoint pen with geometric changes in the barrel. Opaque matt housing and push-button, metal clip and metal tip chrome plated.

0-0151
Minimum quantity
Advertising code

0-0151 M-SI
Minimum quantity
Advertising code

1.000 pieces
barrel T, clip T

1.000 pieces
barrel T, clip MT/L



Farb-Code/Minen
Colour code/Refills

CHECK M SI
1-0142 M-SI

CHECK frozen M SI
1-0142 TF M-SI

1-0142 M-SI (● 8-0855)		1-0142 TF M-SI (● 8-0856)	
	01-0284		01-0306
	01-0286		01-2747
	01-0280		01-0199
	01-0200		01-0802
	01-0375		01-0336
	01-0340		01-0425
	01-0002		01-0003
	01-0428		01-0116
	01-0001		01-0268
	01-0108		01-0227
	01-0526		01-0151
	01-0219		
	01-0172		
	01-2995		
	01-3262		



umaBlackForest *Pens*

Die schönste Verbindung von Design und Fertigung. Geschmackvoll design in Deutschland. Präzise gefertigt in der Schweiz. Exklusiv zusammengefügt und veredelt im Schwarzwald.

The most beautiful combination of design and manufacturing. Elegant designed in Germany. Precisely manufactured in Switzerland. Exclusively assembled and refined in the Black Forest.

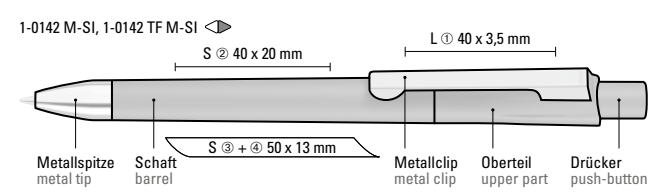

Mix n' Match: Alle Teile können farblich frei kombiniert werden.

1-0142 M-SI: Druckkugelschreiber mit gedeckt matten Gehäuse. Schwerer Metallspitze und Metallclip glanzverchromt.

1-0142 TF M-SI: Druckkugelschreiber mit transparent gefrosteten Gehäuse. Schwere Metallspitze und Metallclip glanzverchromt.

Mindestbestellmenge Werbeschlüssel 1.000 Stück Schaft S ○, Clip L

Mix n' Match: All parts can be colour-combined freely.

1-0142 M-SI: Retractable ballpoint pen with opaque matt housing. Heavy metal tip and metal clip chrome plated.

1-0142 TF M-SI: Retractable ballpoint pen with transparent frosted housing. Heavy metal tip and metal clip chrome plated.

Minimum quantity Advertising code 1,000 pieces barrel S ○, clip L



Etui Empfehlung / Case suggestion
 ETUI 0-0942
 Informationen unter www.uma-pen.com
 Information at www.uma-pen.com

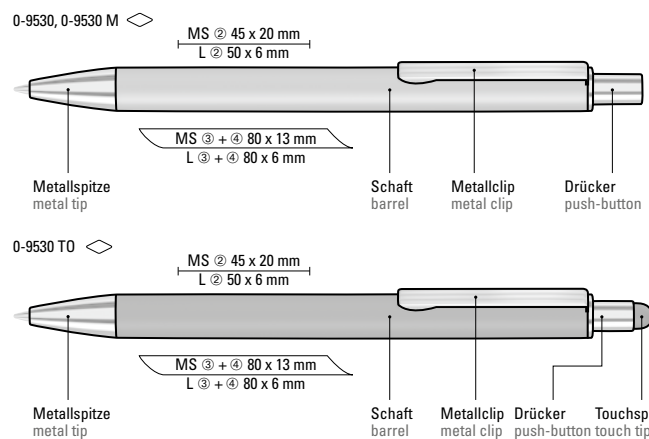

Farb-Code/Minen
 Colour code/Refills

GROOVE
 0-9530

GROOVE M
 0-9530 M

GROOVE TOUCH
 0-9530 TO

- 0-9530 (● 8-0855)
- 66-2995
 - 66-0293
 - 66-0201
 - 66-0376
 - 66-0355
 - 66-0002
 - 66-0004
 - 66-0001
 - 66-0241
 - 66-1585
 - 66-2397
- 0-9530 M (● 8-0855)
- 66-0002
 - 66-0001
- 0-9530 TO (● 8-0855)
- 66-0002
 - 66-0001
 - 8-0855



UMA PRIME



Die Modelle eignen sich für eine
 Laserung in weiß.
 The models are suitable for
 laser engraving in white.

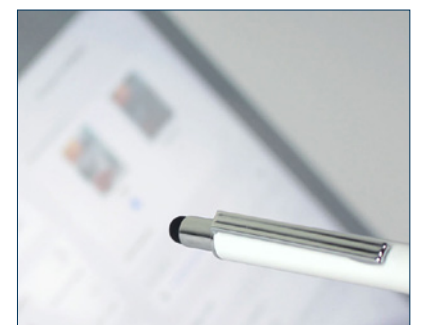
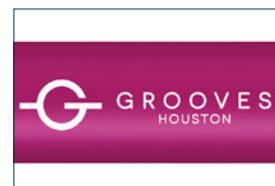

0-9530: Metall-Druckkugelschreiber mit matter Oberfläche, Metallclip mit eingelassenen Rillen, Metallspitze und Drücker in silber glänzend.

0-9530 M: Metall-Druckkugelschreiber mit matter Oberfläche, Metallclip mit eingelassenen Rillen, Metallspitze und Drücker in schwarz matt.

0-9530 TO: Metall-Druckkugelschreiber mit matter Oberfläche, Metallclip mit eingelassenen Rillen, Metallspitze in silber glänzend und Drücker mit integrierter Touchscreensteuerung.

Mindestbestellmenge
 Werbeschlüssel

300 Stück
 Schaft MS/L

0-9530: Metal retractable ballpoint pen with matt finish, metal clip with recessed grooves, metal tip and push-button in silver.

0-9530 M: Metal retractable ballpoint pen with matt finish, metal clip with recessed grooves, metal tip and push-button in black.

0-9530 TO: Metal retractable ballpoint pen with matt finish, metal clip with recessed grooves, metal tip in silver and push-button with integrated touch screen control.

Minimum quantity
 Advertising code

300 pieces
 barrel MS/L



0-9733 ◊

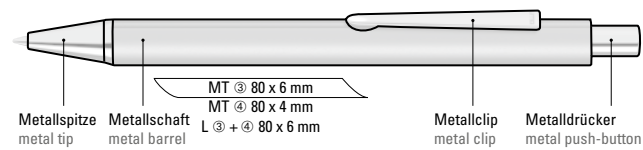

0-9733 GUM, 0-9733 M GUM ◊

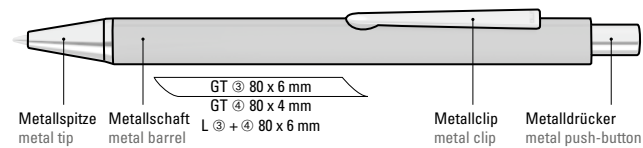

Farb-Code/Minen
Colour code/Refills

PYRA
0-9733

PYRA GUM
0-9733 GUM

PYRA M GUM
0-9733 M GUM

- 0-9733 (● 8-0855)
 - 66-0004
 - 66-0001
- 0-9733 GUM (● 8-0855)
 - 66-2995
 - 66-0293
 - 66-0201
 - 66-0376
 - 66-0355
 - 66-0002
 - 66-0422
 - 66-0241
 - 66-1585
 - 66-2397
- 0-9733 M GUM (● 8-0855)
 - 66-0002
 - 8-0855



Die Modelle eignen sich für eine Hochglanzlaserung.
The models are suitable for high gloss laser engraving.

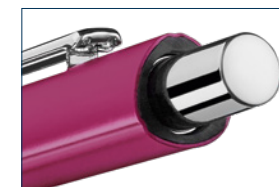

0-9733: Metall-Druckkugelschreiber mit mattem Dreikantgehäuse, Metallclip, Metallspitze und Drücker in silber glänzend.

0-9733 GUM: Metall-Druckkugelschreiber mit Softtouch-Dreikantgehäuse, Metallclip, Metallspitze und Drücker in silber glänzend.

0-9733 M GUM: Metall-Druckkugelschreiber mit Softtouch-Dreikantgehäuse, Metallclip, Metallspitze und Drücker in schwarz matt.

0-9733
Mindestbestellmenge
Werbeschlüssel

0-9733 GUM, 0-9733 M GUM
Mindestbestellmenge
Werbeschlüssel

300 Stück
Schaft MT/L

300 Stück
Schaft GT/L

0-9733: Metal retractable ballpoint pen with triangular barrel matt finished, metal clip, metal tip and push-button in glossy silver.

0-9733 GUM: Metal retractable ballpoint pen with softtouch triangular barrel, metal clip, metal tip and push-button in glossy silver.

0-9733 M GUM: Metal retractable ballpoint pen with softtouch triangular barrel, metal clip, metal tip and push-button in matt black.

0-9733
Minimum quantity
Advertising code

0-9733 GUM, 0-9733 M GUM
Minimum quantity
Advertising code

300 pieces
barrel MT/L

300 pieces
barrel GT/L



Farb-Code/Minen
Colour code/Refills

MESH
0-9350

MESH R
0-9352 R

0-9350 (● 8-0888)



0-9352 R (● 8-0806)



Das Modell in schwarz eignet sich für eine Hochglanzlasergravur in silber.
The model in black is suitable for high gloss laser engraving in silver.



Die Modelle in silber und GUN eignen sich für eine Laserung in beige.
The models in silver and GUN are suitable for laser engraving in beige.



Etui Empfehlung / Case suggestion
ETUI 0-0918
Informationen unter www.uma-pen.com
Information at www.uma-pen.com

0-9350 ◊

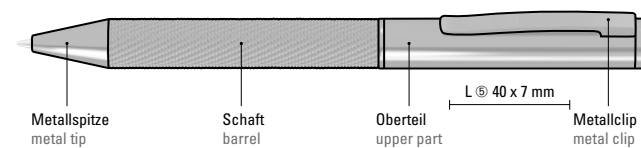

0-9352 R ◊

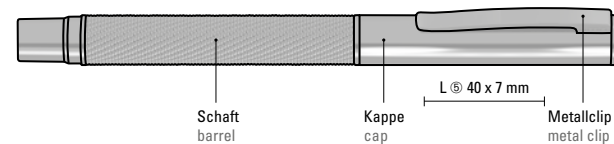

0-9350: Metall-Drehkugelschreiber glänzend lackiert mit Softdrehmechanik und gefedertem Metallclip. Schaft mit integriertem Meshband.

0-9352 R: Metall-Rollerball glänzend lackiert mit gefedertem Metallclip und Schaft mit integriertem Meshband.

0-9350
Mindestbestellmenge
Werbeschlüssel

0-9352 R
Mindestbestellmenge
Werbeschlüssel

100 Stück
Oberteil L

100 Stück
Kappe L

0-9350: Metal twist ballpoint pen in glossy lacquered finish with a soft twist mechanism and a spring-mounted metal clip. Barrel with integrated mesh band.

0-9352 R: Metal rollerball in glossy lacquered finish with spring-mounted metal clip and barrel with integrated mesh band.

0-9350
Minimum quantity
Advertising code

0-9352 R
Minimum quantity
Advertising code

100 pieces
upper part L

100 pieces
cap L



Farb-Code/Minen
Colour code/Refills

TITAN ONE
0-9360

TITAN ONE R
0-9362 R

0-9360 (● 8-0888)
0-9362 R (● 8-0806)

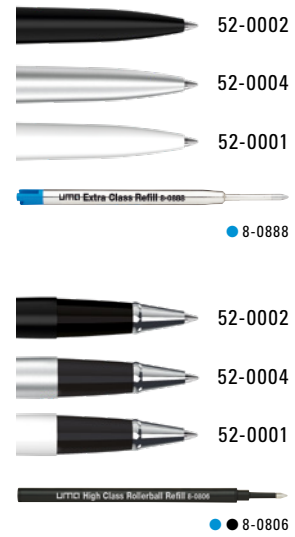

Die Modelle eignen sich für eine Hochglanzlaserung.
The models are suitable for high gloss laser engraving.

Etui Empfehlung
Case suggestion



METALLETUI ML 0-0962 ML
Informationen unter www.uma-pen.com
Information at www.uma-pen.com

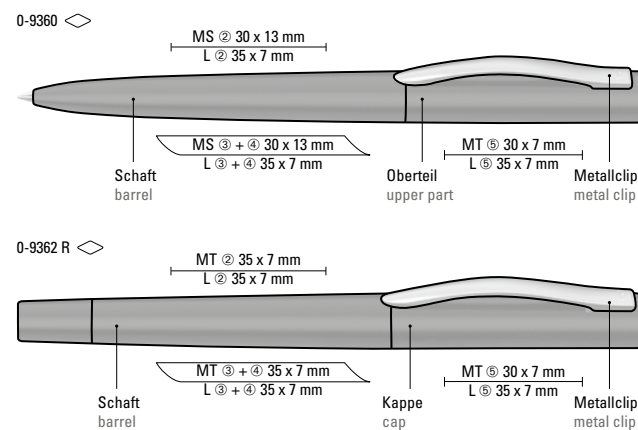

0-9360: Metall-Drehkugelschreiber mit matt lackiertem Gehäuse, Softdrehmechanik und gefedertem, gebürstetem Clip.

0-9362 R: Metall-Rollerball mit matt lackiertem Gehäuse, gefedertem, gebürstetem Clip.

0-9360
Mindestbestellmenge
Werbeschlüssel

100 Stück
Schaft MS/L, Oberteil MT/L

0-9362 R
Mindestbestellmenge
Werbeschlüssel

100 Stück
Schaft MT/L, Kappe MT/L

0-9360: Metal twist ballpoint pen with matt lacquered housing, soft twist mechanism and spring-mounted metal clip brush-finished.

0-9362 R: Metal rollerball with matt lacquered housing, spring-mounted metal clip brush-finished.

0-9360
Minimum quantity
Advertising code

100 pieces
barrel MS/L, upper part MT/L

0-9362 R
Minimum quantity
Advertising code

100 pieces
barrel MT/L, cap MT/L



0-9190 LUX (● 8-0888)



0-9190 C (● 8-0888)

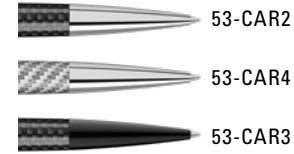

0-9190 M (● 8-0888)

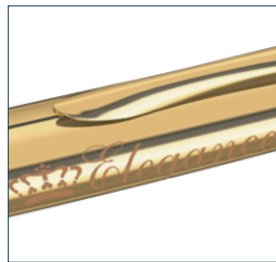

Das Modell 0-9190 LUX eignet sich für Laserung in beige.
The model 0-9190 LUX is suitable for laser engraving in beige.



Das Modell 0-9190 M eignet sich für Hochglanzlaserung.
The model 0-9190 M is suitable for high gloss laser engraving.

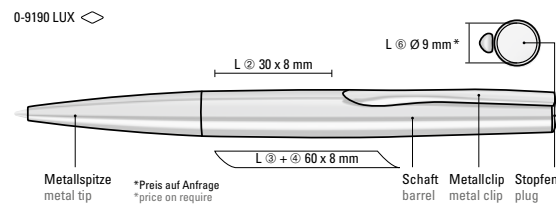

0-9190 LUX: Metall-Drehkugelschreiber mit 18 ct vergoldetem Gehäuse, gefederter Metallclip, schwere Metallspitze und Softdrehmechanik.

0-9190 LUX: Metal twist ballpoint pen with 18 ct gold plated housing, spring-mounted metal clip, heavy metal tip and soft twist mechanism.

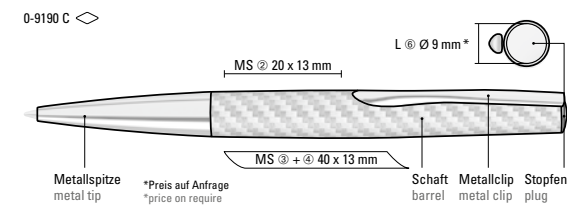

0-9190 C: Metall-Drehkugelschreiber mit Schaft aus Carbonfaser in schwarz oder silber, gefederter Metallclip und schwere Metallspitze glanzverchromt bzw. Schaft aus Carbonfaser in schwarz, Metallclip und schwere Metallspitze schwarz matt lackiert und Softdrehmechanik.

0-9190 M: Metall-Drehkugelschreiber mit gedeckt matt lackiertem Gehäuse in schwarz, gefederter Metallclip, schwere Metallspitze und Softdrehmechanik.

0-9190 C
Mindestbestellmenge 100 Stück
Werbeschlüssel Schaft MS, Stopfen L

0-9190 M
Mindestbestellmenge 100 Stück
Werbeschlüssel Schaft MS/L, Stopfen L

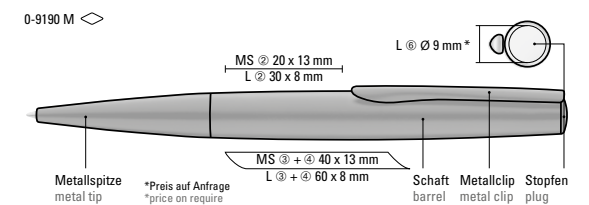

0-9190 C: Metal twist ballpoint pen with carbon fibre barrel in black or silver, spring-mounted metal clip and glossy chrome plated tip or black carbon fibre barrel, spring-mounted metal clip and metal tip in black matt and soft twist mechanism.

0-9190 M: Metal twist ballpoint pen with matt lacquered housing in black, spring-mounted metal clip, heavy metal tip and soft twist mechanism.

0-9190 C
Minimum quantity 100 pieces
Advertising code barrel MS, plug L

0-9190 M
Minimum quantity 100 pieces
Advertising code barrel MS/L, plug L

0-9190 LUX: Metall-Drehkugelschreiber mit 18 ct vergoldetem Gehäuse, gefederter Metallclip, schwere Metallspitze und Softdrehmechanik.

Mindestbestellmenge 100 Stück
Werbeschlüssel Schaft L, Stopfen L

Artikel-Nr. Item No.	Modell Model	Werbeschlüssel Advertising code			Mindestmenge Minimum quantity	Seite Page
		Schaft Barrel	Clip Clip	Kappe Cap		
0-0017 RECY	PIXEL RECY	S ○	T		1.000	37
0-0037	HAPPY	S ○	T		1.000	53
0-0037 RECY	HAPPY RECY	S ○	T		1.000	33
0-0037 TF	HAPPY frozen	S ○	T		1.000	53
0-0063 RECY	ON TOP RECY	S	T/HD/RD		1.000	36
0-0092 RECY	YES RECY	S ○	T		1.000	32
0-0125 GUM	SKY GUM	GS	T		1.000	55
0-0125 M-SI GUM	SKY M SI GUM	GS	MT/L		1.000	55
0-0133 GUM	TRINITY GUM	GT/HD/RD	T		1.000	45
0-0133 KG-SI GUM	TRINITY KG SI GUM	GT/HD/RD	T		1.000	45
0-0133 KT GUM	TRINITY K transparent GUM	GT/HD/RD	T		1.000	47
0-0133 KT-SI GUM	TRINITY K transparent SI GUM	GT/HD/RD	T		1.000	47
0-0133 SI GUM	TRINITY SI GUM	GT/HD/RD	T		1.000	45
0-0151	STREAM	T	T		1.000	57
0-0151 M-SI	STREAM M SI	T	MT/L		1.000	57
0-0177	CORAL	S	T		1.000	51
0-0177 GUM	CORAL GUM	GS	GT		1.000	49
0-0177 SI	CORAL SI	S	T		1.000	51
0-0177 TF	CORAL frozen	S	T		1.000	51
0-0177 TF-SI	CORAL frozen SI	S	T		1.000	51
0-0183 RECY	VANE RECY	S	T/HD/RD		1.000	35
0-2210 F	RECYCLED PET PEN STEP F	S	T		1.000	5
0-2210 TF	RECYCLED PET PEN STEP frozen	S	T		1.000	5
0-2250	RECYCLED PET PEN PRO	S	T		1.000	7
0-2250 ANTIBAC	RECYCLED PET PEN PRO antibacterial	S	T		1.000	25
0-2250 F	RECYCLED PET PEN PRO F	S	T		1.000	7
0-2250 F OCEAN	RECYCLED PET PEN PRO F ocean	S	T		1.000	21
0-2250 F-SI	RECYCLED PET PEN PRO F SI	S	T		1.000	19
0-2250 F TO	RECYCLED PET PEN PRO F TOUCH	S	T		1.000	27
0-2250 T	RECYCLED PET PEN PRO transparent	S	T		1.000	9
0-2250 TF	RECYCLED PET PEN PRO frozen	S	T		1.000	9
0-2250 TF-SI	RECYCLED PET PEN PRO frozen SI	S	T		1.000	19
0-2252 R	RECYCLED PET PEN PRO R	S	T	T	1.000	15
0-2254 FL	RECYCLED PET PEN PRO FL	S	T	T	1.000	15
0-2255	RECYCLED PET PEN PRO LIQEO	S	T	T	1.000	17
0-7200	RECYCLED PET PEN ALUMA	MS/MT/L	MT/L		300	29
0-7200 T	RECYCLED PET PEN ALUMA transparent	MS/MT/L	MT/L		300	29
0-9190 C	ELEGANCE C	MS	L Stopfen/plug		100	69
0-9190 LUX	ELEGANCE LUX	L	L Stopfen/plug		100	69
0-9190 M	ELEGANCE M	MS/L	L Stopfen/plug		100	69
0-9190 WOOD	ELEGANCE WOOD	MS/L	L Stopfen/plug		100	43
0-9350	MESH			L	100	65
0-9352 R	MESH R			L	100	65
0-9360	TITAN ONE	MS/L		MT/L	100	67
0-9362 R	TITAN ONE R	MT/L		MT/L	100	67
0-9370	TITAN WOOD	MS/L		L	100	41
0-9372 R	TITAN WOOD R	MT/L		L	100	41
0-9530	GROOVE	MS/L			300	61
0-9530 M	GROOVE M	MS/L			300	61
0-9530 TO	GROOVE TO	MS/L			300	61
0-9733	PYRA	MT/L			300	63
0-9733 GUM	PYRA GUM	GT/L			300	63
0-9733 M GUM	PYRA M GUM	GT/L			300	63
1-0142 M-SI	CHECK M SI	S ○	L		1.000	59
1-0142 TF M-SI	CHECK frozen M SI	S ○	L		1.000	59
5-5400	TREE	MS/L			300	39
5-5900	LEAF	MS/L			300	39

ZUKUNFTSTRÄCHTIG
 RECYCLINGIDEE
 VERANTWORTUNG
 KLIMANEUTRAL
 NACHHALTIGKEIT
 INNOVATIONEN
 RECYCLED PET PEN
 AUSGEZEICHNET
 MENSCHENWÜRDIG
 UMWELTVERTRÄGLICH
 FSC®-ZERTIFIZIERUNG
 ZUKUNFTSTRÄCHTIG
 RECYCLINGIDEE
 HERAUSFORDERUNG
 VERANTWORTUNG
 RECYCLED PET PEN
 INNOVATIONEN
 KLIMANEUTRAL
 NACHHALTIGKEIT
 MENSCHENWÜRDIG
 HERAUSFORDERUNG
 PEFC-ZERTIFIZIERUNG
 UMWELTVERTRÄGLICH
 AUSGEZEICHNET



Die Handschrift der Werbung

